

HEALTH MONITORING SYSTEM USING GSM MODEM

A project report has been submitted in partial fulfillment of the requirements for the award of the degree of

**BACHELOR OF TECHNOLOGY
IN
ELECTRONICS AND COMMUNICATION ENGINEERING**

Submitted by

J. Bhavani (318126512142)

N. Siva (318126512158)

N.V.K.S Vyahruth (318126512157)

K. Sravani (317126512031)

**Under the guidance of
Dr. G. Manmadha Rao
Professor**

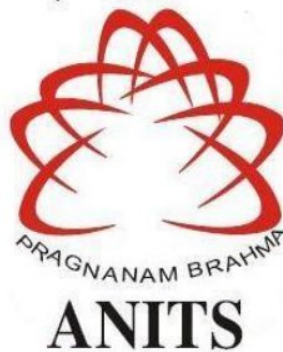

DEPARTMENT OF ELECTRONICS AND COMMUNICATION ENGINEERING

**ANIL NEERUKONDA INSTITUTE OF TECHNOLOGY AND SCIENCES
(UGC AUTONOMOUS)**

**(Permanently Affiliated to AU, Approved by AICTE and Accredited by
NBA & NAAC with 'A' Grade)**

Sangivalasa, Bheemili Mandal, Visakhapatnam (A.P)

2018 – 2022

DEPARTMENT ELECTRONICS AND COMMUNICATION ENGINEERING

**ANIL NEERUKONDA INSTITUTE OF TECHNOLOGY AND SCIENCES
(UGC AUTONOMOUS)**

(Permanently Affiliated to AU, Approved by AICTE and Accredited by NBA & NAAC

With 'A' Grade)

Sangivalasa, Bheemunipatnam, Visakhapatnam (A.P)

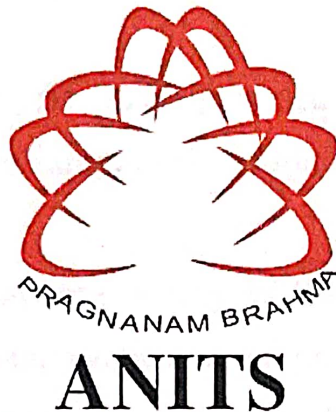

CERTIFICATE

This is to certify that the project report entitled “**HEALTH MONITORING SYSTEM USING GSM MODEM**” submitted by **J.Bhavani(318126512142), N. Siva (318126512158), N.V.K.S Vyahruth (318126512157),K. Sravani (317126512031)** in partial fulfillment of the requirements for the award of the degree of **Bachelor of Technology in Electronics and Communication Engineering** of Andhra University, Visakhapatnam is a record of bonafide work carried out under my guidance and supervision.



Project Guide
Dr. G. Manmadha Rao
Professor
Department of ECE
ANITS

Professor
Department of E.C.E
Anil Neerukonda
Institute of Technology & Sciences
Sangivalasa, Visakhapatnam-531162



Head of the Department
Dr. V. Rajyalakshmi
Professor & HOD
Department of ECE
ANITS

Head of the Department
Department of ECE
Anil Neerukonda Institute of Technology & Sciences
Sangivalasa-531 162

ACKNOWLEDGEMENT

We would like to express our deep gratitude to our project guide **Dr. G. Manmadha Rao**, Professor, Department of Electronics and Communication Engineering, ANITS, for his guidance with unsurpassed knowledge and immense encouragement. We are grateful to **Dr. V. Rajyalakshmi**, Head of the Department, Electronics and Communication Engineering, for providing us with the required facilities for the completion of the project work.

We are very much thankful to the **Principal and Management of ANITS** for their encouragement and cooperation to carry out this work.

We express our thanks to all **teaching faculty** of Department of ECE, whose suggestions during reviews helped using accomplishment of our project. We would like to thank **all non-teaching staff** of the Department of ECE, ANITS for providing great assistance in accomplishment of our project.

We would like to thank our parents, friends, and classmates for their Encouragement throughout our project period. Last but not the least, we thank everyone for supporting us directly or indirectly in completing this project successfully.

PROJECT TEAM:

J. Bhavani (318126512142)

N. Siva (318126512158)

N.V.K.S Vyahruth (318126512157)

K. Sravani (317126512031)

ABSTRACT

The new outbreak of Corona virus poses a major threat and has been declared a global public health emergency. Whole World is trying to stop the virus but no efficient tool and strategy is there to control it. Monitoring of Patient's health remotely is really important especially for patients suffering from a long-term disease. Vital signs such as pulse rate, Body temperature needs to be monitored regularly as they are the primary indicators of a human's health. Also, Elderly people gets benefited by making less visits to the hospitals for regular check. Therefore, we intend to bring in a GSM based Patient health monitoring system which helps in the security of patient's health. Remote patient health monitoring is a technology to enable monitoring patient's health outside clinical settings. The system measures the heartbeat and body temperature of patient and then the immediate information will be sent to the registered number. The proposed system is implemented using AVR Family Microcontroller (Arduino UNO) which is interfaced with LCD display, heartbeat sensor, temperature sensor (LM35), GSM Modem power supply and a mobile phone. The GSM based Patient health monitoring system works with GSM modem to send the data remotely to the registered number, system powered by 12V transformer. The system efficiently updates doctor about health of patient as well as accurately calculates the health parameter of patient.

| CONTENTS: | Pg. No |
|---|---------------|
| CHAPTER 1: INTRODUCTION | |
| 1.1 Project Objective | 4 |
| 1.2 Project Outline | 7 |
| 1.2.1 Existing System and its problems | 7 |
| 1.2.2 Use of vital signals in health analysis | 7 |
| CHAPTER 2: MOTIVATION | |
| 2.1 Internet of Things in health monitoring | 15 |
| 2.2 Embedded Systems used in real time | 21 |
| 2.3 Proposed System | 23 |
| CHAPTER 3: HARDWARE AND SOFTWARE REQUIREMENT | |
| 3.1 Hardware Requirement | 25 |
| 3.1.1 Arduino | 25 |
| 3.1.2 LM35 Temperature Sensor | 29 |
| 3.1.3 GSM Module | 30 |
| 3.1.4 Pulse Sensor | 33 |
| 3.1.5 Liquid Crystal Display (LCD) | 38 |
| 3.1.6 Power Supply and Connecting wires | 40 |
| 3.2 Software Requirement | 41 |
| CHAPTER 4: DESIGN AND IMPLEMENTATION | |
| 4.1 Process Model | 43 |
| 4.2 Hardware Implementation | 44 |
| 4.3 Software Implementation | 55 |
| CHAPTER 5: RESULTS AND DISCUSSION | 49 |
| CHAPTER 6: CONCLUSION & FURTHER ENHANCEMENTS | 51 |
| REFERENCES | 54 |
| PUBLISHED PAPER IN IJEAT JOURNAL | 55 |

List of figures:

| | |
|---|----|
| Figure 2.1: Block Diagram of proposed system | 23 |
| Figure 3.1: Arduino | 26 |
| Figure 3.2: Temperature Sensor | 29 |
| Figure 3.3: GSM Module | 32 |
| Figure 3.4: Pulse Sensor | 35 |
| Figure 3.5: Interfacing of pulse sensor with Arduino | 37 |
| Figure 3.6: Pin diagram of LCD | 38 |
| Figure 4.1(a): Data flow diagram | 43 |
| Figure 4.1(b): Transmission and Reception of the calculated parameter | 44 |
| Figure 4.2: Circuit Diagram of proposed system | 45 |
| Figure 5.1: Working setup of proposed system | 49 |
| Figure 5.2: Output of the system | 50 |

List of Tables:

| | |
|---------------------------------------|----|
| Table 1.1: Variation of Temperature | 5 |
| Table 1.2: Average Heart Rate | 5 |
| Table 3.1 : Specifications of Arduino | 27 |

CHAPTER 1

INTRODUCTION

1.1 Project Objective

Now Recently Wireless Sensor Networks (WSN) play a vital role in the research, technological community hence resulting in the development of various high-performance smart sensing system. Many new research is focused at improving quality of human life in terms of health by designing and fabricating sensors which are either in direct contact with the human body (invasive) or indirectly (noninvasive) in contact. Health monitoring is an informal, non-statutory method of surveying our workforce for symptoms of ill health, including lower back pain. This type of occupational health management system can enable us, as an employer, to be aware of health problems and intervene to prevent problems being caused or made worse by work activities. Another important role of health monitoring is to give feedback into a system that reviews the current control methods in place. In addition, there are specific regulations dealing with manual handling and whole-body vibration in the workplace. To ensure we are complying with our duties under these regulations we should refer to HSE (health system engineering) guidance, if manual handling or whole-body vibration are risks in our workplace. Whole body vibration is particularly prevalent in those that drive industrial and parameters and the sampled parameters are wireless.

The development of biomedical engineering is responsible for improving healthcare diagnosis, monitoring and therapy. The novel idea behind Health line is to provide quality health service to one and all. The idea is driven by the vision of a cable free biomedical monitoring system. On body sensors monitor the vital parameters (blood pressure, ECG, temperature and heart beat rate) and transmits the data to doctor 's end via wireless communication network. Periodic health monitoring (or preventative care) allows people to discover and treat health problems early, before they have consequences.

1.1.1 Body Temperature: The below figure shows the changes in body temperature through the day. As you can be seen, body temperature peaks around the midday, when the human body is the most active and plummets during hours of sleep or rest. This was calculated assuming that daytime is the active half of the day.

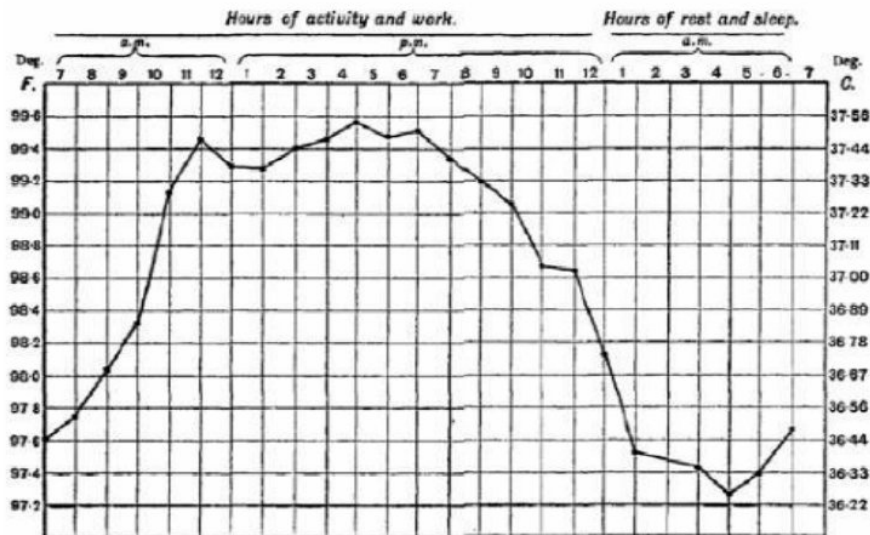

Table 1.1: Variation of Temperature

1.1.2 Heart Rate:

A pressure wave gets out along the arteries with a velocity of few meters per seconds when the heart beats which is faster than the actual flow of blood. One can feel the pressure wave at the wrist. But the pressure wave can rise up the volume of blood in the tissues.

| AGE OF PERSON | RANGE OF HEART RATE | AVERAGE RATE |
|----------------|---------------------|--------------|
| 0-1 Month | 100-180 | 140 |
| 2-3 Month | 110-180 | 145 |
| 4-12 Month | 80-180 | 130 |
| 1-3 Years | 80-160 | 120 |
| 4-5 Years | 80-120 | 100 |
| 6-8 Years | 70-115 | 100 |
| 9-12 Years | 60-110 | 92.5 |
| 12-16 Years | 60-110 | 85 |
| Above 16 Years | 60-100 | 80 |

Table 1.2: Average Heart Rate

The medical implications of body temperature are profound. It is the foremost medical check to confirm the health status of a human body. The change in body temperature can be used as an

indicator of various diseases and medical abnormalities, including hypothermia or heatstroke, both of which can be life threatening. Body temperature can also be used as an indication of infection or other diseases and also as a means of measuring the effectiveness of fever reducing medicine. Body temperature varies depending on the part of the body from which it is measured. However, it has become standard medical procedure to check body temperature from the skin under the armpit or from the mouth or rectum. The temperature measured from the skin is understandably slightly lower and less accurate than that measured from the cavities. Hence, the vital signs monitor is primarily used to monitor patients, it is crucial that this device measures the temperature in real time which is another aim of this project.

The main objective of our project is to make health monitoring system simple and accurate currently in our paper we are monitoring only body temperature and heart rate but we can further expand our system by measuring various parameters like ECG, blood pressure etc. Another objective of our research is to analyze these parameters to identify accurately the problem to give patient better cure as soon as possible and these analyze data can wirelessly transmit to the doctor anywhere in the world by using GSM. It is very costly to measure each single parameter so in our design we are combining all three parameters in single device.

1.1.3 Photolithosmograph:

To detect the volume of blood, PPG is the simplest and cost-effective technique. A pulse oximeter is frequently used to get a PPG which enlightens the skin and counts the changes in light absorption. Typically to find out the flow of blood, an emitter-receiver combination is used in PPG. It is made up with a combination of an infrared emitter and a photodiode, which are used to transmit the variations in infrared reflectance due to the fact of continuously changing flow of blood. To pass the light through the skin, an LED is used. The detector placed on the surface of skin, can find out the reflected or transmitted waves from several depths and from the tissues of higher and weaker absorption. However, a wide change of PPG signals depends on a various number of facts.

1.2Project Outline

1.2.1Existing System and its problems

Many existing systems for Real Time Health Monitoring generally use microcontroller ATMEL 89C51 (μc 8051). It does the same job by using additional devices. The microcontroller-controlled system contains essentially four parts, i.e., the process, the analog to digital converter, the control algorithm, and the clock. The times when the measured signals are converted to digital form are called the sampling instants; the time between successive samplings is called the sampling period and is denoted by h . The output from the process is a continuous time signal. The output is converted into digital form by the A – D converter. The conversion is done at the sampling times.

Problems associated with existing system :

Many existing systems for temperature and pulse monitoring generally uses micro-controller ATMEL 89C51 (μc 8051). Due to using micro controller 8051 the process of making whole device becomes not only very complex but also difficult and tedious. For operation it requires A-D converter, external clock, microcontroller development board.

Consequently, the problems are as follows: -

- a) It takes comparatively more time to process.
- b) It requires additional devices for operation.
- c) It requires external clock.
- d) Programming for micro-controller 8051 is difficult.
- e) Circuit size becomes large.
- f) PCB making becomes complex, difficult and tedious.
- g) For programming it requires development system.

1.2.2Use of vital signals in health analysis

Chronic diseases have a significant influence on healthcare where cost of curing chance of attack is common among people. Changes in demographic structure and lack of health and social care personnel force us to study new innovations, which could over a relief to these

challenges. Elderly people have to make frequent visits to their doctor to get their vital signs measured. Regular monitoring of vital signs is essential as they are primary indicators of an individual's physical wellbeing.

These vital signs include,

- a. Pulse rate
- b. Blood pressure
- c. Body temperature

The goal is to develop a low cost, low power, reliable, non-intrusive, and non-invasive vital signs monitor which collect different type of body and the sampled parameters are wireless. sensing and data conditioning system to acquire accurate heart rate, ECG, blood pressure, and body temperature readings. After processing of data, we have to find a proper method of transmission and signal display. Remote patient monitoring (RPM) is a technology to enable monitoring of patients outside of conventional clinical settings (e.g., in the home), which may increase access to care and decrease healthcare delivery costs.

1.2.2.1 Gathering vital signals:

Pulse is the rate at which our heart beats. Our pulse is usually called our heart rate, which is the number of times our heart beats each minute (bpm). But the rhythm and strength of the heartbeat can also be noted, as well as whether the blood vessel feels hard or soft. Changes in our heart rate or rhythm, a weak pulse, or a hard blood vessel may be caused by heart disease or another problem. As our heart pumps blood through our body, we can feel a pulsing in some of the blood vessels close to the skin's surface, such as in our wrist, neck, or upper arm. Counting our pulse rate is a simple way to find out how fast our heart is beating. The normal core body temperature of a healthy, resting adult human being is stated to be at 98.6 degrees Fahrenheit or 37.0 degrees Celsius. Though the body temperature measured on an individual can vary, a healthy human body can maintain a fairly consistent body temperature that is around the mark of 37.0 degrees Celsius. The normal range of human body temperature varies due to an individual 's metabolism rate; the higher (faster) it is the higher the normal body temperature or the slower the metabolic rate the lower the normal body temperature. Other factors that might affect the body temperature of an individual may be the time of day or the part of the body in which the temperature is measured at. The body temperature is lower in the morning, due to the rest the body received, and higher at night after a day of muscular activity and after food intake. Body temperature also varies at different parts of the body. Oral

temperatures, which are the most convenient type of temperature measurement, is at 37.0 °C. This is the accepted standard temperature for the normal core body temperature. Axillary temperatures are an external measurement taken in the armpit or between two folds of skin on the body. This is the longest and most inaccurate way of measuring body temperature, the normal temperature falls at 97.6 °F or 36.4 °C. Rectal temperatures are an internal measurement taken in the rectum, which fall at 99.6 °F or 37.6 °C. It is the least time consuming and most accurate type of body temperature measurement, being an internal measurement. But it is definitely, by far, not the most comfortable method to measure the body temperature.

1.2.2.2 Remote Patient Monitoring:

Remote Patient Monitoring is a method that helps in healthcare delivery using the latest advances in IT. This is almost taking the major part of healthcare to the doorsteps instead of the patient having to visit the clinic or hospital. Remote Patient Technology uses specific devices that gather information about patient health to be conveyed to the doctor with the desired regularity.

The devices used in RPM are similar to Smart phones and tabs but are built to gather measurement and connect up with a specific facility or a doctor for data transmission. Patients would require wearing specific sensors that need to be hooked with these devices that transmit the physiological information to the doctor. The doctors then use this information to assess the patient condition and advise the next actions, medication, and care. RPM monitors can also be used to set reminders about medication, exercises, diet, sleep or even instructions to fight anxiety. Depending on the choice, the RPM devices also support self-monitoring technology that helps patients take care of their health by themselves by going through instructions, flow charts, and other information. In the cases of Home Healthcare providers, the visiting nurses or medical staff could be assisted with the RPM technology located at the patient 's place.

The concept of RPM is made possible with the widespread availability of wearable devices that provide physiological measurements to the doctors and the medical staff even from a remote location. This enables the patient 's condition assessment without requiring patient proximity. Connected health devices run the gamut from wearable heart monitors, to Bluetooth-enabled scales, to Fitbits. They provide health measures of patients and transmit them back to providers – or in some cases are reported back to providers – to facilitate healthcare decisions from afar. Remote patient monitoring technologies are akin to telemedicine technologies, since they automatically observe ,

report on patients, often with chronic illnesses, so caregivers can remotely keep tabs on patients.

In the middle of the COVID-19 pandemic, connected health and RPM are more important than ever, because they enable physicians to monitor patients without having to come into contact with them, thus preventing the spread of the novel corona virus. They also keep patients with less severe cases out of hospitals, so preserving precious bed space for patients with severe cases. Hospitals across the nation are using connected health and RPM to great effect during the pandemic.

Independent and convenient, healthy living is the aim of any human being no matter their age, gender, location or health status. However, there are limitations due to age, illness, medication, hospitalization, epidemic, pandemic and other circumstances. Health monitoring systems have evolved to assist convenient healthy living, more accessible communication between healthcare givers and patients for close monitoring, measurement of vital health parameters, routine consultation and overall healthy living. Moreover, with the recent advances in information and communication technologies (ICT) through the adoption of Internet of Things (IoT) technology, smart health monitoring and support systems now have a higher edge of development and acceptability for enhanced healthy living.

The study conducted by Zikali, revealed that with the rapid increase in the population of older or senior citizens, patients who require health monitoring have also increased exponentially. The same study predicts that by the year 2045 the number of senior citizens who are considered the most vulnerable in society will exceed the number of children and young adults as a recent population census shows an increase in older people. However, a shortage of home health helpers, nursing assistants and home healthcare givers is looming worldwide, which makes care for the elderly expensive. Therefore, a health monitoring system can play a vital role in lessening physical contact, hospitalization, consultation time, queuing list and overall health cost for a patient while also reducing workload, burden and stress on medical staff. Advancements in information and communication technologies for connectivity anywhere and anytime make a valuable contribution to the development of the modern healthcare system utilized in telemedicine solutions and other portable medical platforms.

The advent of smart home technologies proposes healthy living and improved quality of healthcare support services for the elderly and handicapped for independent and comfortable lifestyles while at home, instead of nursing homes, hospitals or other confinement facilities. The

healthcare module, as a part of the smart home automation system, will improve healthcare facilities for patients while at home or in remote locations outside the hospitals. Thus, there is a reduction in depression that arises from loneliness in the hospital wards for patients. The doctors can monitor patients from their office, prescribe medication and view measured vital health parameters for a remote diagnosis. Also, the rapid improvement of software and hardware technologies in the smart home healthcare system, makes it possible for patients, especially the elderly or disabled, to control certain home appliances with ease from devices such as smart phones, tablets, laptops, internet, etc.

Incorporating RPM in chronic disease management can significantly improve an individual's quality of life. It allows patients to maintain independence, prevent complications, and minimize personal costs. RPM facilitates these goals by delivering care right to the home. In addition, patients and their family members feel comfort knowing that they are being monitored and will be supported if a problem arises. This is particularly important when patients are managing complex self-care processes such as home hemodialysis. Physiological data such as blood pressure and subjective patient data are collected by sensors on peripheral devices. Examples of peripheral devices are: blood pressure cuff, pulse ox meter, and glucometer. The data are transmitted to healthcare providers or third parties via wireless telecommunication devices. The data are evaluated for potential problems by a healthcare professional or via a clinical decision support algorithm, and patient, caregivers, and health providers are immediately alerted if a problem is detected. As a result, timely intervention ensures positive patient outcomes. The newer applications also provide education, test and medication reminder alerts, and a means of communication between the patient and the provider.

Remote Patient Monitoring System: It is made up of five major parts, those are: -

- **Input Devices:** Devices that stay with the patients along with the sensors that not only provide a regular transmission of the patient conditions through data related to various parameters, but also provide assistance to the patients by providing reminders, alerts, prescriptions, communication with the doctor, and any self-assistance required. The patient can manually enter the data or else the sensors can automatically feed them into the device. These devices are the chief components that differentiate an RPM system from any other Telehealth system.

- **Local Data Storage:** For a given treatment cycle it is essential to hold the data related to the patient health parameters in the device (such as a USB device) or in a central repository to be extracted by the device whenever required.
- **Diagnostic Application:** The application on the patient 's device includes diagnostic applications as it could be necessary in some cases such as heart patients. This might even advise a patient about the next steps to be taken.
- **Network:** Network and communication is another part of the solution that actually helps connect the EHR system with the patient 's input device. The service providers often provide this network to establish the patient-doc
- tor communication. There are different types of networks available and it is important to ensure the ability of the input device to connect to the network. This could be achieved via Wi-Fi, Wired or Mobile connection or in some cases Bluetooth connection of different generations and types.
- **Central Repository:** Patient data is stored in EHR systems maintained by the clinics and the hospitals. This could be formed by one or more of data repositories applicable to a healthcare system. Healthcare software can use this data and provide the information to the medical practitioners related to the patient 's condition for diagnosis, medication, and treatment.

Remote Patient Monitoring – Challenges and Barriers

There are many challenges and barriers related to the systems and regulations that must be overcome in order to successfully achieving a fool-proof functioning of an RPM system:

- **Network Availability and Connectivity:**

The success of RPM (or even Telehealth) depends heavily on the availability of network and connectivity of the device, especially at any patient 's premises. This is true for Telehealth in general and any type of network, WIFI, Mobile, Wired, or any other type. Especially when large data packets are being transmitted over the network, interruptions could hamper the diagnosis; for example, in any case that requires continuous monitoring such as the heart conditions or brain conditions, network interruptions at critical times may prove to be unwanted. The input devices often are situated close to the patients, so the patients need to

ensure availability of the uninterrupted network for continuous communication with the EHR system. Depending on the adoption rate, Network providers could come up with network types that assure this.

- **Sensors and wearable devices:**

An RPM system 's chief differentiator is the inclusion of sensors and wearable devices. These could be available in various sizes and types which patients could be asked to wear on various parts of the body; it is the question of suitability, usability, comfort, and convenience. For example, a device like Fitbit (activity tracking watches) or such others may not be suitable for shower although it is water resistant. Many of the electronic devices are unsuitable for use near hot places like barbecues. Some of the battery-operated devices could run out of power faster in cold weathers. In general, the design of devices especially the wearable ones, may require revision from time to time.

- **Training and Adaptability:**

Even if the RPM devices are usable to a good extent, a multiplicity of sensors and complexity of devices may require some training to be imparted to the patients. The extent of training may depend on the patient 's background and conditions.

- **Accuracy of data:**

The success of the RPM system also depends on the data quality. Even if the system, the sensors, and the network are running fine, the reliability of the data provided to the diagnosing practitioner would be dependent on the accuracy of data from the system. This may need verification and calibration of the RPM system from time to time in order to maintain reasonable accuracy.

- **Security and Privacy:**

Since the RPM systems work over digital networks, they are prone to hacking and the associated breach of privacy and other security issues. Security standards normally applicable to other Healthcare management systems could become applicable to RPM systems also. HIPAA and similar other norms require patient privacy to be protected; although this could

be part of information security and perceived as a larger subject requiring a healthy clinic-patient relationship.

- **FDA Approval:**

The RPM systems and devices must meet the FDA regulation norms for healthcare use. FDA approval itself brings a challenge to the system providers; it could require scrutiny of manufacturing/development processes, quality assurance, patient worthiness certification and life cycle assessments. While FDA approval itself may be beneficial to the patients which could ensure high device standards, it may eventually end up pushing the device costs higher due to related overheads.

- **Cost and Affordability:**

The process overheads and extra approval steps may lead to increased costs thus making RPM devices expensive to adopt. However mass scale adoption in due course of time could make it affordable and even necessary.

CHAPTER 2

MOTIVATION

2.1 Internet of Things in health monitoring

The Internet of Things (IoT) and Smart Grid are of great importance in promoting and guiding development of information technology and economic. At Present, the application of the IoT develops rapidly, but due to the special requirements of some applications, the existing technology cannot meet them very good. Much research work is doing to build IoT.Wi-Fi-based Wireless Sensor Network (WSN) has the features of high bandwidth and rate, non-line-transmission ability, large-scale data collection and high cost-effective, and it has the capability of video monitoring, which cannot be realized with ZigBee. The research on Wi-Fi-based WSN and its application has high practical significance to the development of the Internet of Things and Smart Grid. Based on the current research work of applications in the Internet of Things and the characteristics of Wi-Fi-based WSN, this paper discusses the application of WiFi-based WSN in Internet of Things, which includes Smart Grid, Smart Agriculture and Intelligent environment protection. Monitoring Systems and Sensors systems have increased in importance over the years. However, increases in measurement points mean increases in installation and maintenance cost. The development work of a Wi-Fi based Smart Wireless Sensor Network for monitoring an Agricultural Environment. The system is capable of intelligently monitoring agricultural conditions in a pre-programmed manner. The system consists of three stations: Sensor Node, Router, and Server. The system is designed for monitoring of the climate condition in an agricultural environment such as field or greenhouse, the sensor station is equipped with several sensor elements such as Temperature, humidity, light, air pressure, soil moisture and water level. In addition, investigation was performed in order to integrate a novel planar electromagnetic sensor for nitrate detection. The communication between the sensor node and the server is achieved via 802.11g wireless modules. Sensors are used for measurements and for acquisition of data but they require an effective data transfer mechanism to enable full-fledged applications that utilize the data they collect Embedded systems is one of the most important, yet overlooked subjects in the electronics world. When we think technology, mobile phones, tablets and laptops come to mind, but the devices that actually help us in our daily lives are not talked too much about.

They 're often confused with larger or more general-purpose computers, and it's sometimes difficult to discern between one and the other.

The Internet of things (IoT) describes the network of physical objects—a.k.a. "things"—that are embedded with sensors, software, and other technologies for the purpose of connecting and exchanging data with other devices and systems over the Internet.

Things have evolved due to the convergence of multiple technologies, Real time analytics, machine learning ,ubiquitous computing, commodity sensors and embedded systems. Traditional fields of embedded systems, wireless sensor networks, control systems, automation(including home and building automation), and others all contribute to enabling the Internet of things. In the consumer market, IoT technology is most synonymous with products pertaining to the concept of the "smart home", including devices and appliances(such as lighting fixtures, thermostats, home security systems and cameras, and other home appliances) that support one or more common ecosystems, and can be controlled via devices associated with that ecosystem, such as smart phones and smart speakers. The IoT can also be used in healthcare systems.

There are a number of serious concerns about dangers in the growth of the IoT, especially in the areas of privacy and security, and consequently industry and governmental moves to address these concerns have begun including the development of international standards.

An IoT ecosystem consists of web-enabled smart devices that use embedded systems, such as processors, sensors and communication hardware, to collect, send and act on data they acquire from their environments. IoT devices share the sensor data they collect by connecting to an IoT gate way or other edge device where data is either sent to the cloud to be analyzed or analyzed locally. Sometimes, these devices communicate with other related devices and act on the information they get from one another. The devices do most of the work without human intervention, although people can interact with the devices -- for instance, to set them up, give them instructions or access the given data.

The connectivity, networking and communication protocols used with these web-enabled devices largely depend on the specific IoT applications deployed. IoT can also make use of artificial intelligence (AI) and machine learning to aid in making data collecting processes easier and more dynamic.

The internet of things helps people live and work smarter, as well as gain complete control over their lives. In addition to offering smart devices to automate homes, IoT is essential to

business. IoT provides businesses with a real-time look into how their systems really work, delivering insights into everything from the performance of machines to supply chain and logistics operations.

IoT enables companies to automate processes and reduce labor costs. It also cuts down on waste and improves service delivery, making it less expensive to manufacture and deliver goods, as well as offering transparency into customer transactions. As such, IoT is one of the most important technologies of everyday life, and it will continue to pick up steam as more businesses realize the potential of connected devices to keep them competitive.

Advantages of IoT:

Some of the advantages of IoT include the following:

- ability to access information from anywhere at any time on any device;
- improved communication between connected electronic devices;
- transferring data packets over a connected network saving time and money; and
- automating tasks helping to improve the quality of a business's services
- reducing the need for human intervention.

Disadvantages of IoT:

- As the number of connected devices increases and more information is shared between devices, the potential that a hacker could steal confidential information also increases.
- Enterprises may eventually have to deal with massive numbers -- maybe even millions -- of IoT devices, and collecting and managing the data from all those devices will be challenging.
- If there's a bug in the system, it's likely that every connected device will become corrupted.
- Since there's no international standard of compatibility for IoT, it's difficult for devices from different manufacturers to communicate with each other.

IoT standards and frameworks:

There are several emerging IoT standards, including the following:

- IPv6over Low-Power Wireless Personal Area Networks (*6LoWPAN*) is an open standard defined by the Internet Engineering Task Force (IETF). The 6LoWPAN standard enables any low-power radio to communicate to the internet, including 804.15.4, Bluetooth Low Energy (BLE) and Z-Wave(for home automation).
- ZigBee is a low-power, low-data rate wireless network used mainly in industrial settings. ZigBee is based on the Institute of Electrical and Electronics Engineers (IEEE) 802.15.4 standard. The ZigBee Alliance created Dot dot, the universal language for IoT that enables smart objects to work securely on any network and understand each other.
- LiteOS is a Unix-like operating system (OS) for wireless sensor networks. LiteOS supports smart phones, wearable's, intelligent manufacturing applications, smart homes and the internet of vehicles (IoV). The OS also serves as a smart device development platform.
- One M2M is a machine-to-machine service layer that can be embedded in software and hardware to connect devices. The global standardization body, One M2M, was created to develop reusable standards to enable IoT applications across different verticals to communicate.
- Data Distribution Service (DDS) was developed by the Object Management Group (OMG) and is an IoT standard for real-time, scalable and high-performanceM2Mcommunication.
- Advanced Message Queuing Protocol (AMQP) is an open source published standard for asynchronous messaging by wire. AMQP enables encrypted and interoperable messaging between organizations and applications. The protocol is used in client-server messaging and in IoT device management.
- Constrained Application Protocol (CoAP) is a protocol designed by the IETF that specifies how low-power, compute-constrained devices can operate in the internet of things.
- Long Range Wide Area Network (Lora WAN) is a protocol for WANs designed to support huge networks, such as smart cities, with millions of low-power devices.

IoT frameworks include the following:

- Amazon Web Services (AWS) IoT is a cloud computing platform for IoT released by Amazon. This framework is designed to enable smart devices to easily connect and securely interact with the AWS cloud and other connected devices.
- Arm Mbed IoT is a platform to develop apps for IoT based on Arm microcontrollers. The goal of the Arm Mbed IoT platform is to provide a scalable, connected and secure environment for IoT devices by integrating Mbed tools and services.
- Microsoft's Azure IoT Suite is a platform that consists of a set of services that enables users to interact with and receive data from their IoT devices, as well as perform various operations over data, such as multidimensional analysis, transformation and aggregation, and visualize those operations in a way that's suitable for business.
- Google's Brillo/Weave is a platform for the rapid implementation of IoT applications. The platform consists of two main backbones: Brillo, an Android based OS for the development of embedded low-power devices, and Weave, an IoT-oriented communication protocol that serves as the communication language between the device and the cloud.
- Calvin is an open source IoT platform released by Ericsson designed for building and managing distributed applications that enable devices to talk to each other.
- Calvin includes a development framework for application developers, as well as a runtime environment for handling the running application.

Consumer and enterprise IoT applications:

There are numerous real-world applications of the internet of things, ranging from consumer IoT and enterprise IoT to manufacturing and industrial IoT (IIoT). IoT applications span numerous verticals, including automotive, telecom and energy.

In the consumer segment, for example, smart homes that are equipped with smart thermostats, smart appliances and connected heating, lighting and electronic devices can be controlled remotely via computers and smart phones.

Wearable devices with sensors and software can collect and analyze user data, sending messages to other technologies about the users with the aim of making users' lives easier and more comfortable. Wearable devices are also used for public safety -- for example, improving first responders' response times during emergencies by providing optimized routes to a location or by tracking construction workers' or firefighters' vital signs at life-threatening sites.

In healthcare, IoT offers many benefits, including the ability to monitor patients more closely using an analysis of the data that's generated. Hospitals often use IoT systems to complete tasks such as inventory management for both pharmaceuticals and medical instruments.

Smart buildings can, for instance, reduce energy costs using sensors that detect how many occupants are in a room. The temperature can adjust automatically -- for example, turning the air conditioner on if sensors detect a conference room is full or turning the heat down if everyone in the office has gone home.

In agriculture, IoT-based smart farming systems can help monitor, for instance, light, temperature, humidity and soil moisture of crop fields using connected sensors. IoT is also instrumental in automating irrigation systems.

In a smart city, IoT sensors and deployments, such as smart streetlights and smart meters, can help alleviate traffic, conserve energy, monitor and address environmental concerns, and improve sanitation.

IoT security and privacy issues:

The internet of things connects billions of devices to the internet and involves the use of billions of data points, all of which need to be secured. Due to its expanded attack surface, IoT security and IoT privacy are cited as major concerns.

In 2016, one of the most notorious recent IoT attacks was Mirai, a botnet that infiltrated domain name server provider Dyn and took down many websites for an extended period of time in one of the biggest distributed denial-of-service (DDoS) attacks ever seen. Attackers gained access to the network by exploiting poorly secured IoT devices.

Because IoT devices are closely connected, all a hacker has to do is exploit one vulnerability to manipulate all the data, rendering it unusable. Manufacturers that don't update their devices regularly or at all leave them vulnerable to cybercriminals.

Additionally, connected devices often ask users to input their personal information, including names, ages, addresses, phone numbers and even social media accounts information that's invaluable to hackers.

Hackers aren't the only threat to the internet of things; privacy is another major concern for IoT users. For instance, companies that make and distribute consumer IoT devices could use those devices to obtain and sell users' personal data.

Beyond leaking personal data, IoT poses a risk to critical infrastructure, including electricity, transportation and financial services.

2.2 Embedded Systems used in real time

An embedded processor is a type of microprocessor designed into a system to control electrical and mechanical functions. Embedded processors are usually simple in design, limited in computational power and I/O capabilities, and have minimal power requirements. At a basic level, embedded processors are a CPU chip placed in a system that it helps control. Embedded processors are often confused with microcontrollers. While they do perform similar functions, they integrate with their given system in different ways. The actual functions they perform can also be different as well.

Microcontrollers are the result of technological advances decreasing the size of controllers. Eventually, all of the components of a controller including I/O devices and memory evolved into a single chip, giving us the —micro in microcontrollers. These chips are small, self-contained devices that have all of the features necessary to control the system they are embedded in. This control autonomy is the primary difference between microcontrollers and embedded processors. Embedded processors require other external components such as integrated memory and peripheral interfaces to perform their designated functions. The two devices are frequently referred to as one device because embedded processors are often components within a microcontroller.

An embedded system is a computer system, made from a combination of hardware and software that is used to perform a specific task. A lot of embedded systems are created with time constraints in mind. In some situations, crossing time limits might not amount to much, but in some, it may actually be a disaster. For example, if the embedded system in a car 's braking system does not strictly adhere to time, it may result in an accident. However, if a time limit is passed on something less severe, it may just result in reduced performance. The processors found in common personal computers (PC) are general-purpose or universal processors. They are complex in design because these processors provide a full scale of features and a wide spectrum of functionalities. They are designed to be suitable for a variety of applications. On the other hand, another class of embedded processors focuses on performance. These embedded processors are powerful and packed with advanced chip- design technologies, such as advanced pipeline and parallel processing architecture. These processors are designed to satisfy those applications with intensive computing requirements not achievable with general-purpose processors. Overall, system and application speeds are the main concerns. Data storage is the process of ensuring that research data is stored, archived or disposed of in a safe and secure manner during and after the conclusion of a research project. This includes the development of policies and procedures to manage data handled electronically as well as through nonelectronic means. Proper planning for data handling can also result in efficient and economical storage, retrieval, and disposal of data. In the case of data handled electronically, data integrity is a primary concern to ensure that recorded data is not altered, erased, lost or accessed by unauthorized users. All the above survey insists the need of real time health monitoring system which helps in critical situations.

2.3 Proposed System

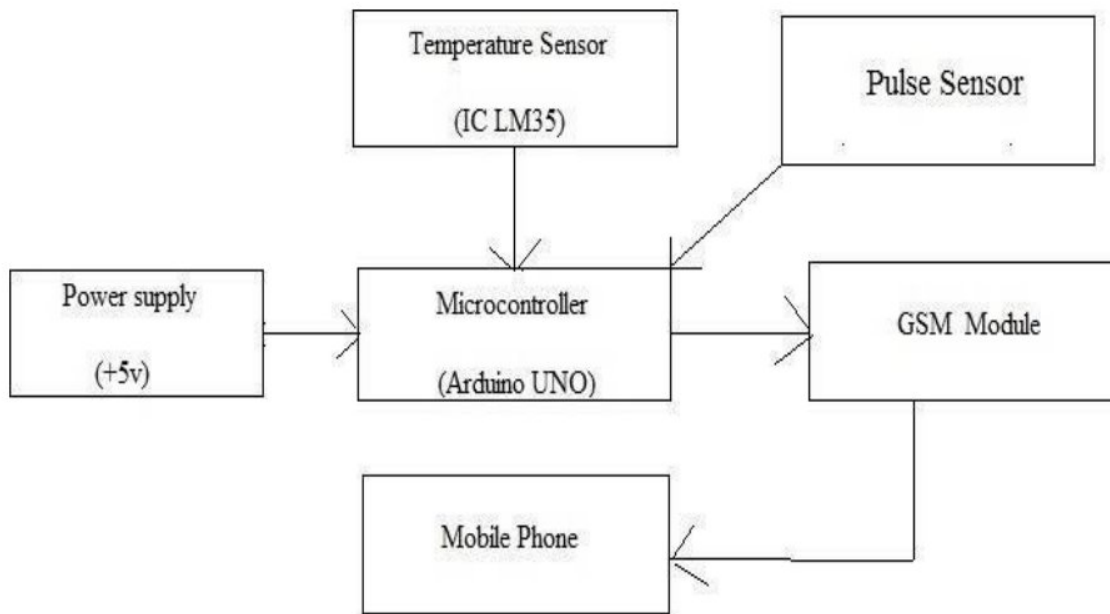

Figure2.1: Block Diagram of Proposed System

In our project we are designing such type of device which is used for continuous monitoring of patients in hospital. We introduce —GSM Based Patient Monitoring System Using Biomedical Sensors|. In previous research we have seen that either the data is monitoring in simple screen or send it by GSM, but in our project the new thing is that we can continue monitor the Heart Rate and human body Temperature and we can also analyze his/her health condition using arduino software, which is used as the integrating platform for acquiring, processing and transmitting data and it has provide graphical platform to analyze.1 then the analyzed data can send to doctor or parents of patient using GSM Technology. Later we can also introduce IOT technology to make it more flexible and more accurate that doctor can monitor his patient condition by simple clicking on web page which is connected to Arduino software using File Transfer Protocol (FTP). Overall, we are introducing such type of design which can monitor health condition and analyze the parameter and give an alert if something going wrong and we can transmit data wirelessly anywhere by using GSM technology. In our project we have discussed the modern visionary of healthcare industry is to provide better healthcare to patient anytime and anywhere in the world in a more economic and patient

friendly manner. Therefore, for increasing the patient care efficacy, there arises a need to improve the patient monitoring devices. The medical world today faces basic two problems when it comes to patient monitoring, firstly the need of healthcare providers present bedside the patient and secondly the patient is restricted to bed and wired to large machines. In order to achieve better quality patient care, the above cited problems have to be solved. This project discusses the acquisition of physiological parameters such as heart rate, body temperature, ECG and displaying them in graphical user interface for being viewed by the doctor.

CHAPTER 3

HARDWARE AND SOFTWARE REQUIREMENT

3.1 Hardware Requirement

This project is based on both hardware and software. The hardware requirements are as follows: -

3.1.1 Arduino

Arduino is an open-source platform used for building electronics projects. Arduino consists of both a physical programmable circuit board (often referred to as a microcontroller) and a piece of software, or IDE (Integrated Development Environment) that runs on our computer, used to write and upload computer code to the physical board.

The Arduino platform has become quite popular with people just starting out with electronics, and for good reason. Unlike most previous programmable circuit boards, the Arduino does not need a separate piece of hardware (called a programmer) in order to load new code onto the board – we can simply use a USB cable. Additionally, the Arduino IDE uses a simplified version of C++, making it easier to learn to program. Finally, Arduino provides a standard form factor that breaks out the functions of the micro-controller into a more accessible package.

The Arduino is a microcontroller board based on the ATmega8. It has 14 digital - input/output pins (of which 6 can be used as PWM outputs), 6 analog inputs, a 16 MHz ceramic resonator, a USB connection, a power jack, an ICSP header, and a reset button. It contains everything needed to support the microcontroller; simply connect it to a computer with a USB cable or power it with a AC-to-DC adapter or battery to get started. The Uno differs from all preceding boards in that it does not use the FTDI USB-to-serial driver chip. Instead, it features the Atmega16U2 (Atmega8U2 up to version R2) programmed as a USB-to-serial converter. Revision 2 of the Uno board has a resistor pulling the 8U2 HWB line to ground, making it easier to put into DFU mode. Revision of the board has the following new features:



Figure3.1: Arduino

- 1.0 pinout: added SDA and SCL pins that are near to the AREF pin and two other new pins placed near to the RESET pin, the IOREF that allow the shields to adapt to the voltage provided from the board. In future, shields will be compatible with both the board that uses the AVR, which operates with 5V and with the Arduino Due that operates with 3.3V. The second one is a not connected pin, that is reserved for future purposes.
- Stronger RESET circuit.
- AT mega 16U2 replace the8U2.

Each of the 14 digital pins and 6 analog pins on the Uno can be used as an input or output, under software control (using pin Mode(), digital Write(), and digital Read() functions). They operate at 5 volts. Each pin can provide or receive 20 mA as the recommended operating condition and has an internal pull-up resistor (disconnected by default) of 20-50K ohm. A maximum of 40mA must not be exceeded on any I/O pin to avoid permanent damage to the microcontroller. The Uno has 6 analog inputs, labeled A0 through A5; each provides 10 bits of resolution (i.e., 1024 different values). By default, they measure from ground to 5 volts, though it is possible to change the upper end of the range using the AREF pin and the analog Reference () function.

In addition, some pins have specialized functions:

- **Serial /UART:** pins 0 (RX) and 1 (TX). Used to receive (RX) and transmit (TX) TTL serial data. These pins are connected to the corresponding pins of the ATmega8U2 USB-to-TTL serial chip.
- **External interrupts:** pins 2 and 3. These pins can be configured to trigger an interrupt on a low value, a rising or falling edge, or a change in value.
- **PWM**(pulse-width modulation): pins 3, 5, 6, 9, 10, and 11. Can provide 8-bit PWM output with the analog Write () function.
- **SPI**(Serial Peripheral Interface): pins 10 (SS), 11 (MOSI), 12 (MISO), and 13 (SCK). These pins support SPI communication using the SPI library.
- **TWI** (two-wire interface) /**I²C**: pin SDA (A4) and pin SCL (A5). Support TWI communication using the Wire library.
- **AREF** (analog reference): Reference voltage for the analog inputs.

"Uno" means one in Italian and is named to mark the upcoming release of Arduino 1.0. The Uno and version 1.0 will be the reference version of Arduino, moving forward. The Uno is the latest in a series of USB Arduino boards, and the reference model for the Arduino platform.

Table 3.1: Specifications of Arduino

| Parameters For Arduino UNO | Description |
|-----------------------------------|------------------------------------|
| Microcontroller | ATmega328 |
| Operating Voltage | 5V |
| Input Voltage (recommended) | 7-12V |
| Input Voltage (limits) | 6-20V |
| Digital I/O Pins | 14 (of which 6 provide PWM output) |
| Analog Input Pins | 6 |

| | |
|-------------------------|--|
| DC Current per I/O Pin | 40 mA |
| DC Current for 3.3V Pin | 50 mA |
| Flash Memory | 32 KB (ATmega328) of which 0.5 KB used by Bootloader |
| SRAM | 2 KB (ATmega328) |
| EEPROM | 1 KB (ATmega328) |
| Clock Speed | 16 MHz |
| Length | 68.6 mm |
| Width | 53.4 mm |
| Weight | 25 g |

3.1.2 LM35 Temperature Sensor

Temperature is one of the most commonly measured parameters in the world. They are used in your daily household devices from Microwave, fridges, AC to all fields of engineering. Temperature sensor basically measures the heat/cold generated by an object to which it is connected. It then provides a proportional resistance, current or voltage output which is then measured or processed as per our application.

Temperature sensor are basically classified into two types

- Non-Contact Temperature Sensors: These temperature sensors use convection & radiation to monitor temperature
- Contact Temperature Sensors: Contact temperature sensors are then further sub divided into three types
 1. Electro-Mechanical (Thermocouples).
 2. Resistance Temperature Detectors (RTD).
 3. Semiconductor based. (LM35, DS1820 etc.).

The LM35 is a popular and inexpensive temperature sensor. It provides an output voltage of 10.0mV for each degree Centigrade of temperature from a reference voltage. The output of this device can be fed to A/D Converter; any microcontroller can be interfaced with any A/D Converter for reading and displaying the output of LM35. The circuit should be designed, so that output should be at 0V when the temperature is 0 degrees Centigrade and would rise to 1000mV or 1.0V at 100 degrees Centigrade. To get the temperature value accurately, output voltage must be multiplied with 100. For example, if we read 0.50V that would be 50 degrees Centigrade.

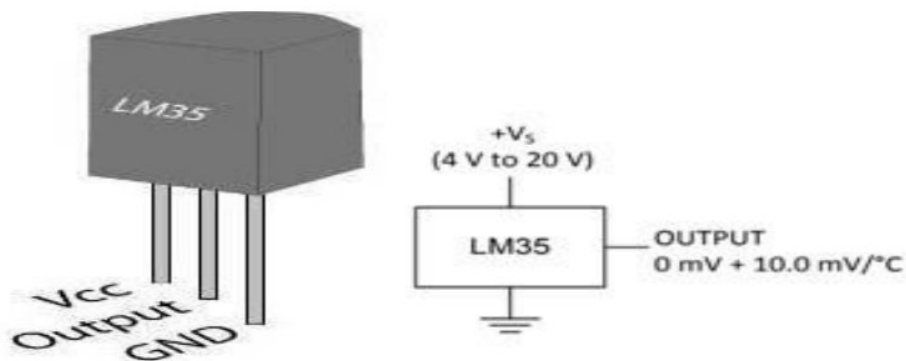

Figure 3.2: LM35 Temperature sensor

The LM35 series are precision integrated-circuit temperature devices with an output voltage linearly proportional to the Centigrade temperature. The LM35 device has an advantage over linear temperature sensors calibrated in Kelvin, as the user is not required to subtract a large constant voltage from the output to obtain convenient Centigrade scaling. The LM35 device does not require any external calibration or trimming to provide typical accuracies of $\pm 1/4^\circ\text{C}$ at room temperature and $\pm 3/4^\circ\text{C}$ over a full -55°C to 150°C temperature range. Lower cost is assured by trimming and calibration at the wafer level. The low output impedance, linear output, and precise inherent calibration of the LM35 device makes interfacing to readout or control circuitry especially easy. The device is used with single power 2 Applications supplies, or with plus and minus supplies. As the LM35 device draws only $60\ \mu\text{A}$ from the supply, it has very low self-heating of less than 0.1°C in still air. The LM35 device is rated to operate over a -55°C to 150°C temperature range, while the LM35C device is rated for a -40°C to 110°C range (-10° with improved accuracy). The LM35-series devices are available packaged in hermetic TO transistor packages, while the LM35C, LM35CA, and LM35D devices are available in the plastic TO-92 transistor package.

If the temperature is 0°C, then the output voltage will also be 0V. There will be rise of 0.01V (10mV) for every degree Celsius rise in temperature. The voltage can convert into temperature using the below formulae.

$$V_{OUT} = 10 \text{ mv/}^{\circ}\text{C} \times T$$

where

- V_{OUT} is the LM35 output voltage
- T is the temperature in °C

LM35 Temperature Sensor Applications:

- Measuring temperature of a particular environment
- Providing thermal shut down for a circuit/component
- Monitoring Battery Temperature
- Measuring Temperatures for HVAC applications.

3.1.3 GSM Module

A GSM modem or GSM module is a hardware device that uses GSM mobile telephone technology to provide a data link to a remote network. From the view of the mobile phone network, they are essentially identical to an ordinary mobile phone, including the need for a SIM to identify themselves to the network. GSM modems typically provide TTL-level serial interfaces to their host. They are usually used as part of an embedded system.

GSM (Global System for Mobile Communications, originally Groupe Special Mobile), is a standard developed by the European Telecommunications Standards Institute (ETSI). It was created to describe the protocols for second-generation (2G) digital cellular networks used by mobile phones and is now the default global standard for mobile communications – with over 90% market share, operating in over 219 countries and territories.

General Packet Radio Service (GPRS) is a packet oriented mobile data service on the 2G and 3G cellular communications system's global system for mobile communications

(GSM). GPRS was originally standardized by European Telecommunications Standards Institute (ETSI) in response to the earlier CDPD and i-mode packet-switched cellular technologies. It is now maintained by the 3rd Generation Partnership Project (3GPP).

A GSM module or a GPRS module is a chip or circuit that will be used to establish communication between a mobile device or a computing machine and a GSM or GPRS system. The modem (modulator demodulator) is a critical part here.

These modules consist of a GSM module or GPRS modem powered by a power supply circuit and communication interfaces (like RS-232, USB 2.0, and others) for computer. A GSM modem can be a dedicated modem device with a serial, USB or Bluetooth connection, or it can be a mobile phone that provides GSM modem capabilities.

GSM/GPRS Modem-RS232 is built with Dual Band GSM/GPRS engine- SIM900A, works on frequencies 900/ 1800MHz. The Modem is coming with RS232 interface, which allows us connect PC as well as microcontroller with RS232 Chip (MAX232). The baud rate is configurable from 9600-115200 through AT command. The GSM/GPRS Modem is having internal TCP/IP stack to enable us to connect with internet via GPRS. It is suitable for SMS, Voice as well as DATA transfer application in M2M interface. The onboard Regulated Power supply allows us to connect wide range unregulated power supply. Using this modem, we can make audio calls, SMS, Read SMS, attend the incoming calls and internet through simple AT commands.

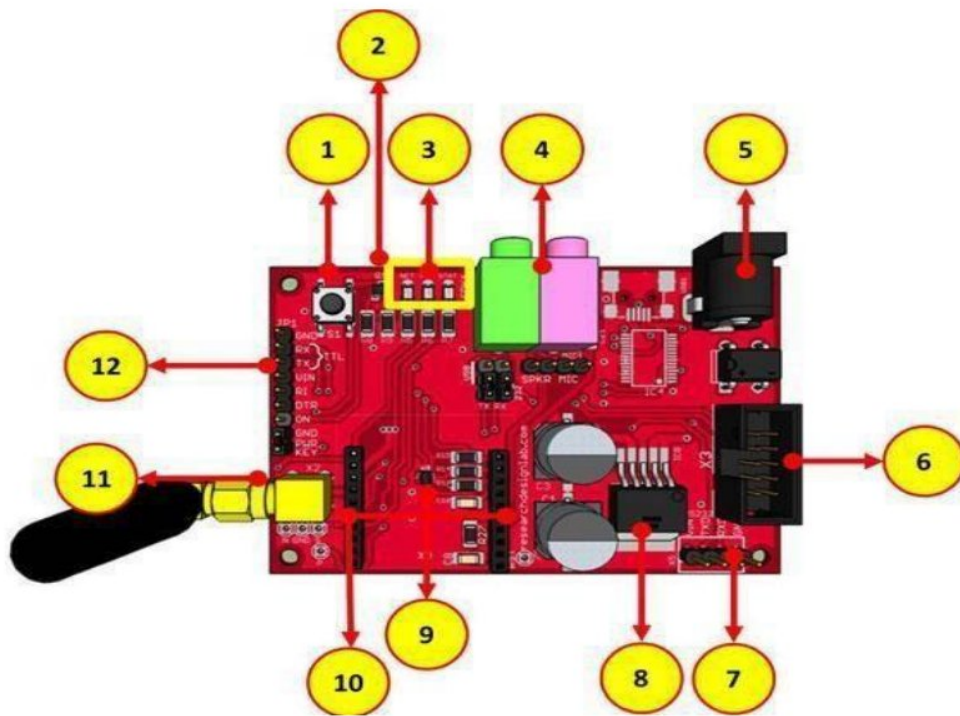

Figure 3.3: GSM Module

1. Power ON reset switch.
2. Sliding SIM holder.
3. Network, Power and Status indicator.
4. MIC and Speaker Socket.
5. Power supply 12V/2A
6. FRC Connector.
7. RS232 header.
8. DC to DC Converter (29302WU IC).
9. ESD Protection enabled.
10. SIM900A stack on header.
11. Stub antenna with SMA connector.
12. General GPIO SIM900A

In our proposed design we use SIM900A instead of SIM300. SIM300 is widely used in GSM modem around the globe, and more popular among students and hobbyists. SIM300 is now succeeding with improved quad band version SIM900A. SIM900A is quad band modem operate in 850, 900, 188, 1900 MHz band and improved with GPRS functionality,

while SIM300 is tri-band GSM modem. All commands of SIM300 are used in SIM900 and SIM300 is not comfortable for web interfacing.

A GSM module or GPRS modules are similar to modems, but there's one difference: A GSM/GPRS Modem is an external equipment, whereas the GSM/GPRS module is a module that can be integrated within an equipment. It is an embedded piece of hardware. A GSM mobile, on the other hand, is a complete system in itself with embedded processors that are dedicated to provide an interface between the user and the mobile network.

Applications of GSM Module:

They can feature all the functionalities of a mobile phone through computer like making and receiving calls, SMS, MMS etc. These are mainly employed for computer-based SMS and MMS services.

The GSM/GPRS module demonstrates the use of AT commands. They can feature all the functionalities of a mobile phone through computer like making and receiving calls, SMS, MMS etc. These are mainly employed for computer-based SMS and MMS services.

3.1.4 Pulse Sensor

The Heartbeat rate information knowing is very useful while doing exercise, studying, etc. But the heartbeat rate can be complicated to calculate. To overcome this problem, the pulse sensor or heartbeat sensor is used. This is a plug & play sensor mainly designed for Arduino board which can be used by makers, students, developers, artists who can utilize the heartbeat information into their projects. This sensor uses an easy optical pulse sensor along with amplification & cancellation of noise to make a circuit. By using this circuit, we can get fast and reliable heartbeat readings. This circuit can be operated with 4mA current and 5V voltage to use in mobile applications.

Optical heart-rate monitors are easy to understand in theory. If we've ever shined a flashlight through our finger tips and seen our heart-beat pulse (a thing most kids have done) we have a good handle on the theory of optical heart-rate pulse sensors.

In an optical heart-rate pulse sensor, light is shot into a fingertip or ear lobe. The light either bounces back to a light sensor, or gets absorbed by blood cells.

As we continue to shine light (into say a fingertip) and take light sensor readings, we quickly start to get a heart-beat pulse reading.

The theory is easy to understand. In practice, it hard to master DIY optical heart-rate sensors, or get them operational at all. There are many tutorials online and in publications describing how to make DIY heart-rate sensors. Through our own personal interests, we 've tried to follow online guides but have generally failed or had unsatisfactory results. As professors, year after year, we see our students attempt to follow these published guides and also either fail in getting anything to work, or get poor results. It could very well be human/user-error on our parts. But from our view, making an optical pulse sensor is easier said than done.

So, we set out to make our own optical heart-rate pulse sensor that can be used in our own creative projects and also available to students, makers, game developers, mobile developers, artists, athletic trainers etc.

Over a few months we tested a gaggle of optical sensors and LED colors and found that it was not as easy as many suspects to get reliable heart-rate data through optical means. We could get basic, gross, short-term data, but reliable readings assuming real-world scenarios and real-world user interaction is key. After more experimentation and development, we started to assemble a reliable heart-rate pulse sensor. We fabricated a few test boards and continued to iterate the design. The working of the Pulse/Heart beat sensor is very simple. The sensor has two sides, on one side the LED is placed along with an ambient light sensor and on the other side we have some circuitry. This circuitry is responsible for the amplification and noise cancellation work. The LED on the front side of the sensor is placed over a vein in our human body. This can either be your Finger tip or you ear tips, but it should be placed directly on top of a vein.

Now the LED emits light which will fall on the vein directly. The veins will have blood flow inside them only when the heart is pumping, so if we monitor the flow of blood, we can monitor the heart beats as well. If the flow of blood is detected then the ambient light sensor will pick up lighter since they will reflect ted by the blood, this minor change in received light is analyzed over time to determine our heart beats.

Features:

- Biometric Pulse Rate or Heart Rate detecting sensor
- Plug and Play type sensor
- Operating Voltage: +5V or +3.3V
- Current Consumption: 4mA
- Inbuilt Amplification and Noise cancellation circuit.
- Diameter: 0.625

Thickness: 0.125

As we tried to —wearl the sensor, we discovered that we should make it look and feel like a 1/2-inch button. Its size allows it to clip to earlobes or fingertips easily.

When we add —button holesl to the design it can be easily sewn or attached to various garments and fashion accessories. The final design turned into a button-sized PCB board that holds all the technology, hit all our goals, and is very cute and accessible to a novice or expert users/developers alike.



Figure 3.4: Pulse sensor

The pulse sensor includes a 24 inches color code cable, ear clip, Velcro Dots-2, transparent stickers-3, etc.

- A color code cable is connected to header connectors. So, this sensor is easily connected to an Arduino into the project without soldering.
- An ear clip size is the same as a heart rate sensor and it can be connected using hot glue at the backside of the sensor to wear on the earlobe.
- Two Velcro dots are completely sized toward the sensor at the hook side. These are extremely useful while making a Velcro strap to cover approximately a fingertip. This is used to cover the Sensor around the finger.
- Transparent strikers are protection layers used to protect the sensor from sweaty earlobes and fingers. This sensor includes three holes in the region of the external edge so that one can easily connect anything to it.

Using the pulse sensor is straight forward, but positioning it in the right way matters. Since all the electronics on the sensor are directly exposed it is also recommended to cover the sensor with hot glue, vinyl tape or other non-conductive materials. Also, it is not recommended to handle these sensors with wet hands. The flat side of the sensor should be placed on top of the vein and a slight presser should be applied on top of it, normally clips or Velcro tapes are used to attain this pressure.

To use the sensor simply power it using the Vcc and ground pins, the sensor can operate both at +5V or 3.3V system. Once powered connect the Signal pin to the ADC pin of the microcontroller to monitor the change in output voltage. If you are using a development board like Arduino then you can use the readily available code which will make things a lot easier. Refer the datasheet at the bottom of the page for more information on how to interface the sensor with Arduino and how to mount it.

This sensor used in straight forward, however connecting it in the correct way matters. Because all types of electronic components are directly exposed to the sensor. So, it is mandatory to envelop this sensor by using hot glue, vinyl strip otherwise other types of non-conductive materials.

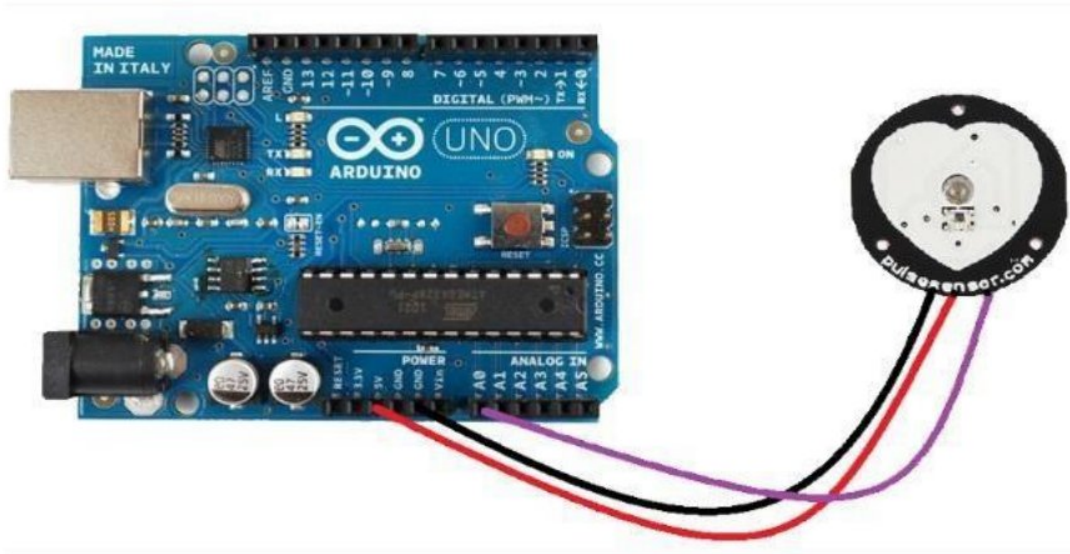

Figure3.5: Interfacing of pulse sensor with Arduino

These sensors cannot be operated with wet hands. The sensor's smooth side must be located on the pinnacle of the vein & press it. Generally, Velcro tapes or clips are utilized to get this force.

This sensor can be used by connecting it to the Arduino board. Once it is connected, then give the power supply with the help of VCC pin and GND pins. The operating voltage of this sensor is +5V or 3.3V. Once the sensor is connected to the development board such as Arduino, then we can use the readily accessible Arduino code to make things easier. Please refer to Arduino site for interfacing of Arduino with pulse sensor and its coding.

Thus, this is all about Pulse Sensor (Heartbeat / Heartrate Sensor). it is open-source and plug-and-play hardware. This sensor can easily include live heartbeat information into their projects. This sensor includes two circuits like an optical amplifying & a noise eliminating. The connection of this sensor on earlobe otherwise fingertip can be done using a Clip, and connect it to Arduino board. So that heart rate can be easily measured. These sensors are used by developers, students, makers, athletes, artists, etc.

Applications:

- Sleep Tracking
- Anxiety monitoring
- Remote patient monitoring/alarm system
- Health bands
- Advanced gaming consoles

3.1.5 Liquid Crystal Display (LCD)

The term LCD stands for liquid crystal display. It is one kind of electronic display module used in an extensive range of applications like various circuits & devices like mobile phones, calculators, computers, TV sets, etc. The main benefits of using this module are inexpensive; simply programmable, animations, and there are no limitations for displaying custom characters, special and even animations, etc.,

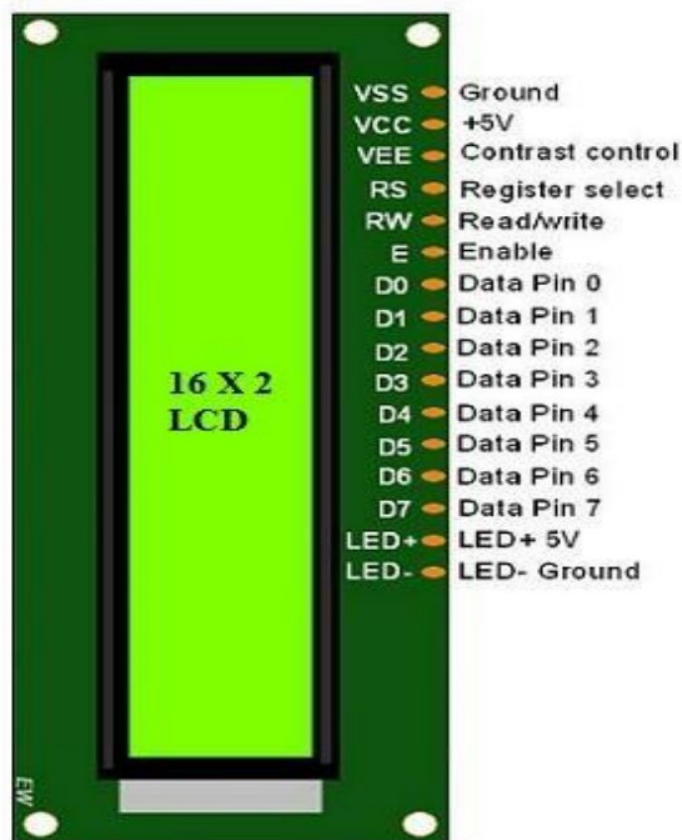

Figure 3.6 Pin diagram of LCD

The 16×2 LCD pinout is shown above.

- Pin1 (Ground/Source Pin): This is a GND pin of display, used to connect the GND terminal of the microcontroller unit or power source.
- Pin2 (VCC/Source Pin): This is the voltage supply pin of the display, used to connect the supply pin of the power source.
- Pin3 (V0/VEE/Control Pin): This pin regulates the difference of the display, used to connect a changeable POT that can supply 0 to 5V.
- Pin4 (Register Select/Control Pin): This pin toggles among command or data register, used to connect a microcontroller unit pin and obtains either 0 or 1(0 = data mode, and 1 = command mode).
- Pin5 (Read/Write/Control Pin): This pin toggles the display among the read or writes operation, and it is connected to a microcontroller unit pin to get either 0 or 1 (0 = Write Operation, and 1 = Read Operation).
- Pin 6 (Enable/Control Pin): This pin should be held high to execute Read/Write process, and it is connected to the microcontroller unit & constantly held high.
- Pins 7-14 (Data Pins): These pins are used to send data to the display. These pins are connected in two-wire modes like 4-wire mode and 8-wire mode. In 4-wire mode, only four pins are connected to the microcontroller unit like 0 to 3, whereas in 8-wire mode, 8-pins are connected to microcontroller unit like 0 to 7.
- Pin15 (+ve pin of the LED): This pin is connected to +5V
- Pin 16 (-ve pin of the LED): This pin is connected to GND.

Features of LCD16x2

The features of this LCD mainly include the following.

- The operating voltage of this LCD is 4.7V-5.3V
- It includes two rows where each row can produce 16-characters.
- The utilization of current is 1mA with no backlight
- Every character can be built with a 5×8-pixel box
- The alphanumeric LCDs alphabets & numbers
- Is display can work on two modes like 4-bit & 8-bit
- These are obtainable in Blue & Green Backlight

- It displays a few custom generated characters

Registers of LCD

A 16×2 LCD has two registers like data register and command register. The RS (register select) is mainly used to change from one register to another. When the register set is '0', then it is known as command register. Similarly, when the register set is '1', then it is known as data register.

Command Register:

The main function of the command register is to store the instructions of command which are given to the display. So that predefined tasks can be performed such as clearing the display, initializing, set the cursor place, and display control. Here commands processing can occur within the register.

Data Register:

The main function of the data register is to store the information which is to be exhibited on the LCD screen. Here, the ASCII value of the character is the information which is to be exhibited on the screen of LCD. Whenever we send the information to LCD, it transmits to the data register, and then the process will be starting there. When register set =1, then the data register will be selected.

3.1.6 Power Supply and Connecting Wires

A power supply is an electronic device that supplies electric energy to an electrical load. The primary function of a power supply is to convert one form of electrical energy to another and, as a result, power supplies are sometimes referred to as electric power converters. Some power supplies are discrete, stand-alone devices, whereas others are built into larger devices along with their loads. Here, we use 5v dc power or sometimes power is given to the circuit directly from computer. A Wire is a single usually cylindrical, flexible strand or rod of metal. Wires are used to bear mechanical loads or electric and telecommunication signals. Wire is formed by drawing the metal through a hole in a die or drawplate.

3.2 Software Requirement

As explained earlier our project requires two-part hardware and software. Hardware parts are explained above and software requires as follows: -

Arduino IDE

The open-source Arduino Software (IDE) makes it easy to write code and upload it to the board. It runs on Windows, Mac OS X, and Linux. The environment is written in Java and based on Processing and other open-source software. This software can be used with any Arduino board. The Arduino development environment contains a text editor for writing code, a message area, a text console, a toolbar with buttons for common functions, and a series of menus. It connects to the Arduino hardware to upload programs and communicate with them.

Software written using Arduino are called sketches. These sketches are written in the text editor. Sketches are saved with the file extension. ino. It has features for cutting/pasting and for searching/replacing text. The message area gives feedback while saving and exporting and also displays errors. The console displays text output by the Arduino environment including complete error messages and other information. The bottom right-hand corner of the window displays the current board and serial port. The toolbar buttons allow us to verify and upload programs, create, open, and save sketches, and open the serial monitor.

The source code for the IDE is released under the GNU General Public License, version 2. The Arduino IDE supports the languages C and C++ using special rules of code structuring. The Arduino IDE supplies a software library from the Wiring project, which provides many common input and output procedures. User-written code only requires two basic functions, for starting the sketch and the main program loop, that are compiled and linked with a program stub *main()* into an executable cyclic executive program with the GNU tool chain, also included with the IDE distribution. The Arduino IDE employs the program *avrdude* to convert the executable code into a text file in hexadecimal encoding that is loaded into the Arduino board by a loader program in the board's firmware. By default, *avrdude* is used as the uploading tool to flash the user code onto official Arduino boards.

Arduino IDE is a derivative of the Processing IDE, however as of version 2.0, the Processing IDE will be replaced with the Visual Studio Code-based Eclipse IDE framework.

With the rising popularity of Arduino as a software platform, other vendors started to implement custom open source compilers and tools (cores) that can build and upload sketches to other micro controllers that are not supported by Arduino's official line of microcontrollers.

CHAPTER 4

DESIGN AND IMPLEMENTATION

4.1 Process Model

In this section we design structure of the system before implementation of circuit. we use advanced microcontroller called Arduino (ATmega8). It has in built with many components like analog to digital converter, clock of 16 MHz, shift registers.

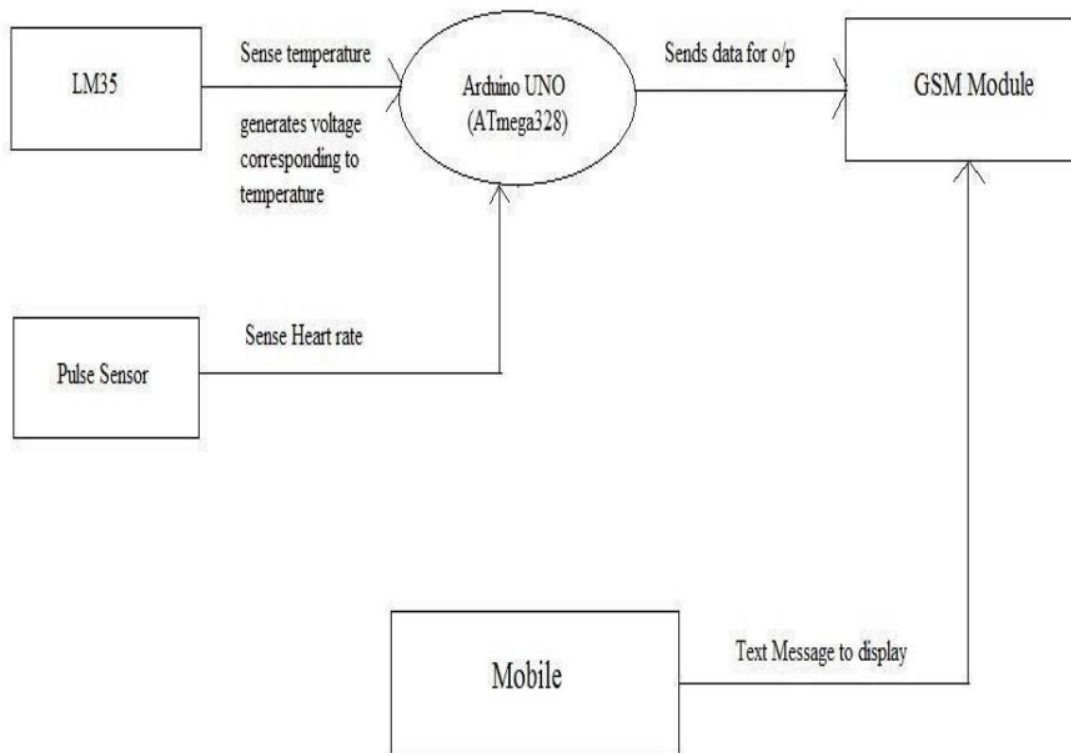

Figure 4.1(a): Dataflow Diagram

In this system we use temperature sensor IC LM35 and Pulse sensor, to detect temperature and heart beat into appropriate voltage. This voltage is given to Arduino. According to program it processes the analog signal into digital and send it via SMS to the concerned people as output (i.e., surrounding temperature of LM35) in both degree centigrade and Fahrenheit units.

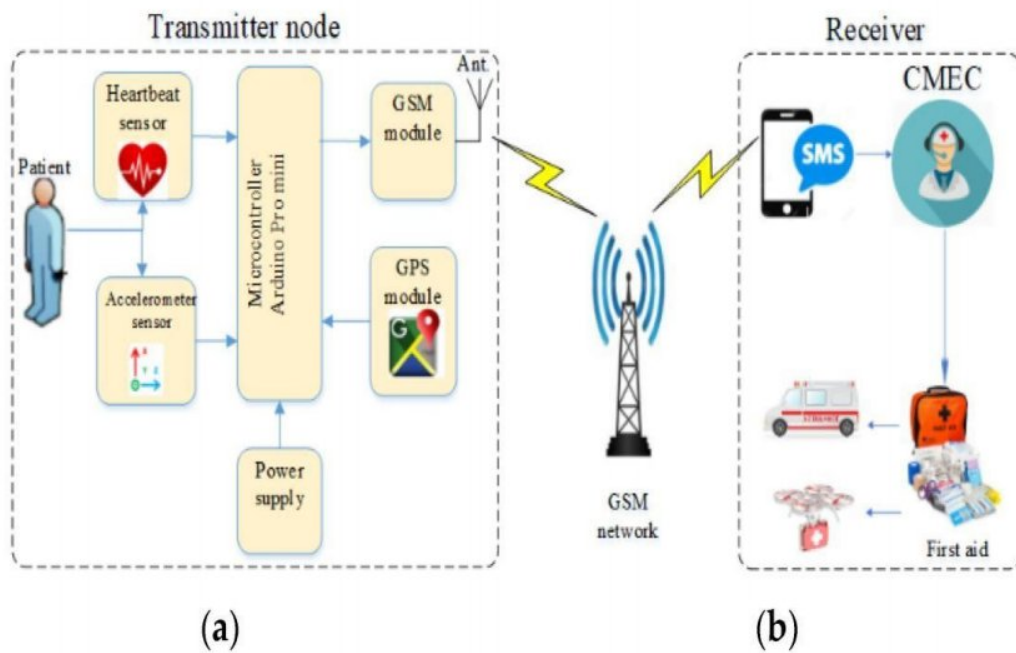

Figure 4.1(b): Transmission and reception of the calculated parameter

4.2 Hardware Implementation

In this section we design our project Real Time Health Monitoring System using Arduino and with the help of temperature sensor IC LM35 and pulse Sensor. The signals sensed from the patients is milli volt but the sensors volt will be 5v sensors will have the amplifiers the sensed signals is amplified and it won't cause harm to human health then the signals are sent to the Arduino. Here we use Arduino (ATmega8) as a controller. This signal is given to the Analog port (A0) and (A1) of the Arduino UNO. Arduino UNO reads analog input and converts this analog voltage into digital bits form using inbuilt A to D converter. It converts analog voltage level in any number between 0 to 1023. It uses 10 bits for processing. This is given to the ATmega328 Micro controller, it then processes the digital data into the respective degree centigrade for temperature and to BHP for the heart rate. Using GSM Module, the results will be continuously transmitted to medical officials and the data will be stored directly to the database.

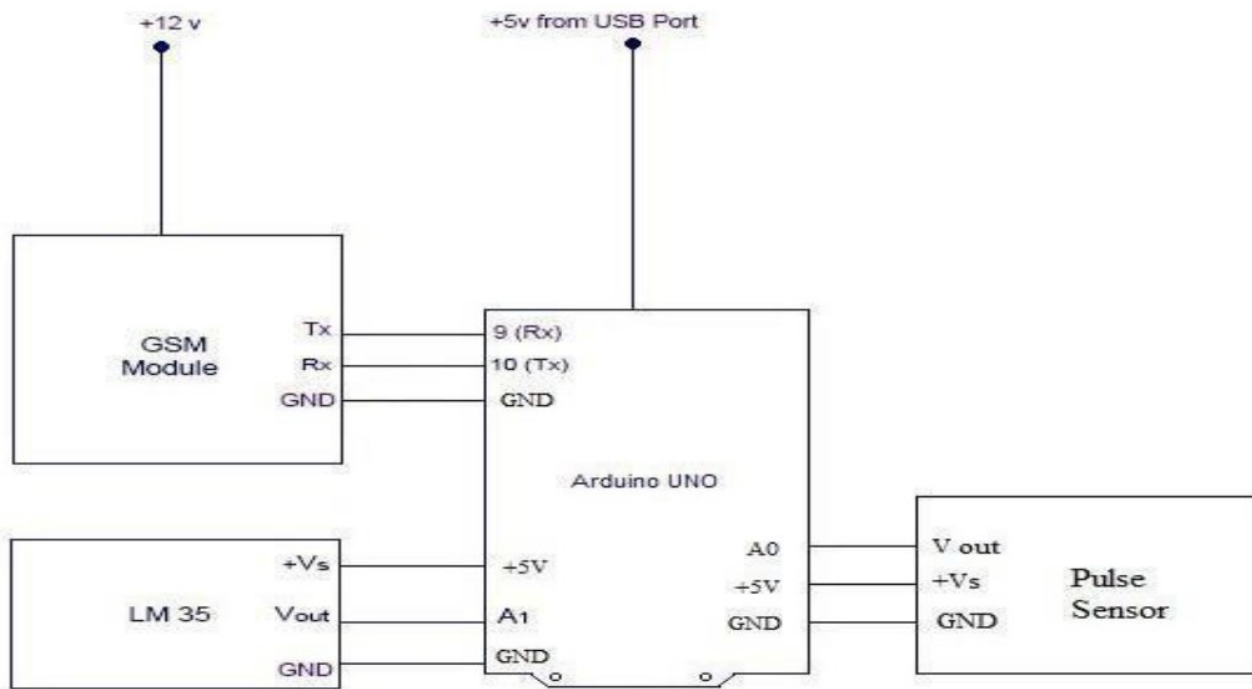

Figure 4.2: Circuit Diagram of proposed system

4.3 Software Implementation

For software implementation we require a software Arduino IDE. This software enables us to load the program in Arduino board.

Source Code:

```
#define USE_ARDUINO_INTERRUPTS true // Set-up low-level interrupts for most accurateBPM
math.
#include <PulseSensorPlayground.h> // Includes the PulseSensorPlayground Library.
#include <LiquidCrystal.h>
// Variables
String name;
const int rs = 12, en = 11, d4 = 5, d5 = 4, d6 = 3, d7 = 2;
const int PulseWire = 0; // PulseSensor PURPLE WIRE connected to ANALOG PIN 0
const int LED13 = 13; // The on-board Arduino LED, close to PIN 13.
int Threshold = 550; // Determine which Signal to "count as a beat" and which to ignore.
#include <SoftwareSerial.h>
```

```

int val;
int tempPin = 3;
SoftwareSerialmySerial(9, 10);
LiquidCrystalcd(rs, en, d4, d5, d6, d7);
// Use the "Getting Started Project" to fine-tune Threshold Value beyond default setting.
// Otherwise leave the default "550" value.
PulseSensorPlaygroundpulseSensor; // Creates an instance of the PulseSensorPlaygroundobjectcalled
"pulseSensor"
void setup() {

lcd.begin(16, 2);
lcd.clear();
lcd.setCursor(4,0);
lcd.print("Health");
lcd.setCursor(0,1);
lcd.print("MonitoringSystem");
mySerial.begin(9600); // Setting the baud rate of GSM Module
Serial.begin(9600); // For Serial Monitor
Serial.println("Enter name");
// Configure the PulseSensor object, by assigning our variables to it.
pulseSensor.analogInput(PulseWire);
pulseSensor.blinkOnPulse(LED13); //auto-magically blink Arduino's LED with heartbeat.
pulseSensor.setThreshold(Threshold);
delay(100);
// Double-check the "pulseSensor" object was created and "began" seeing a signal.
if (pulseSensor.begin()) {
Serial.println("We created a pulseSensorObject !"); //This prints one time at Arduino powerup, or on
Arduino reset.
}
}
void loop() {
if(Serial.available()){
name=Serial.readString();

```



```

Serial.println("loop end");
}
int myBPM = pulseSensor.getBeatsPerMinute(); // Calls function on our pulseSensorobjectthat
returns BPM as an "int".
// "myBPM" hold this BPM value now.
Serial.println(myBPM);
val = analogRead(tempPin);
float mv = ( val/1024.0)*500;
float cel = mv;
float fer = (9*cel)/5 + 32;
if (pulseSensor.sawStartOfBeat()) { // Constantly test to see if "a beat happened".
Serial.println("A HeartBeatHappened ! "); // If test is "true", print a message "a heartbeathappened".
Serial.print("BPM: "); // Print phrase "BPM: "
lcd.clear();
lcd.setCursor(0,0);
lcd.print("BPM:");
Serial.println(myBPM); // Print the value inside of myBPM.
lcd.print(myBPM);
}
lcd.setCursor(0,1);
Serial.print("TEMPRATURE = ");
lcd.print("TM:");
Serial.print(cel);
lcd.print(cel);
Serial.print("*C; ");
Serial.print(fer);
Serial.print("*F \n");
lcd.print("C");
lcd.setCursor(9,1);
lcd.print(";");
lcd.print(fer);
lcd.print("F");
mySerial.println("AT+CMGF=1"); //Sets the GSM Module in Text Mode

```

```

delay(1000); // Delay of 1000 milli seconds or 1 second
mySerial.println("AT+CMGS="+916305580263+"\r"); // Replace x with mobile number
delay(1000);

mySerial.print("Hello ");
mySerial.print(name);
mySerial.println("Welcome to Health Monitoring System!"); // The SMS text us want to send
mySerial.println("Heart Beat Per Minute: ");
mySerial.println(myBPM);
mySerial.println("Temperature: "); // The SMS text us want to send
mySerial.println("In Celsius:");
mySerial.println(CEL);
mySerial.println("In Farenheit");
mySerial.print(FER);
if (FER > 98){
Serial.println("Prescription:");
Serial.println("Please take Dolo-650 Tablet");
mySerial.println("Prescription:");
mySerial.println("Please take Dolo-650 Tablet");
}
if (myBPM > 100){
mySerial.println("Prescription:");
mySerial.println("Please take Atenolol Tablet");
}
delay(100);
mySerial.println((char)26); // ASCII code of CTRL+Z
delay(1000);
Serial.println();
Serial.println("Msg has been sent!");
lcd.clear();
lcd.setCursor(0,0);
lcd.print("Msg was sent !");
}

```

CHAPTER 5

RESULTS AND DISCUSSION

Result of our project work is that the human body parameter like body temperature or heart rate is very sensitive parameter if any physical or non-physical or mental change occur to human then it rapidly changes its value. The standard value of body temperature is 37 Degree Centigrade and heart rate is 72 bit/second. In our proposed design the new thing we add is we are combining two parameters in single device also we analyze the data in Arduino IDE that is main part of our project and the analyzed data is send to the doctor using GSM. The primary objective of our research work to reduce the cost, manpower and the time to send the information, and make analysis as simple as possible

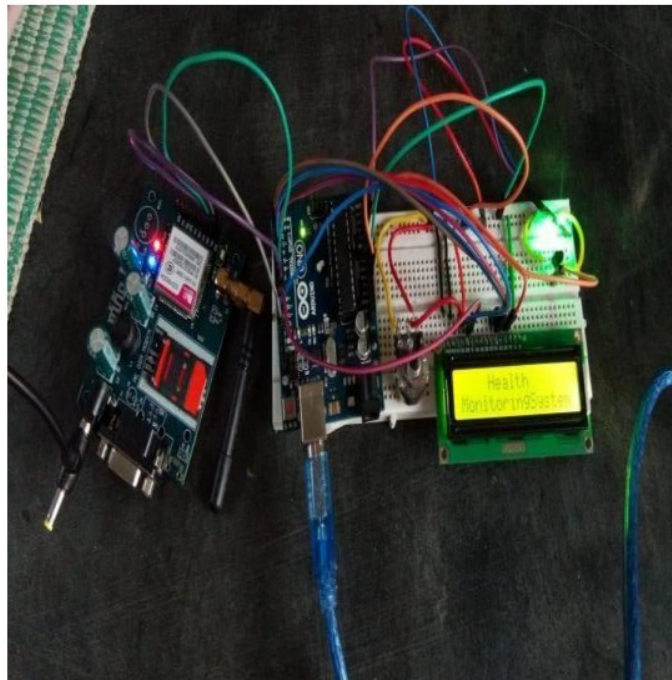

Figure 5.1: Working setup of the proposed system

```
Hello Welcome to Health Monitoring
System!
Heart Beat Per Minute:
72
Temperature:
In Celsius:
36.1
In Farenheit :
97
```

```
Hello Welcome to Health Monitoring
System!
Heart Beat Per Minute:
101
Temperature:
In Celsius:
37.22
In Farenheit
99
Prescription:
Please take Dolo-650 Tablet
Prescription:
Please take Atenolol Tablet
```

Figure 5.2: Output of the proposed system

The project requires three inputs. The inputs are as follows: -

- a) Power supply: - Power supply is the basic need of any electronic circuit. Here we use 5v dc battery to give power Arduino and sometimes we can give power directly from the computer.
- b) Temperature: - It uses Body temperature as input.
- c) Pulse:- Pulse Sensor fits over a fingertip and uses the amount of infrared light reflected by the blood circulating inside to do just that. When the heart pumps, blood pressure rises sharply, and so does the amount of infrared light from the emitter that gets reflected back to the detector.

CHAPTER 6

CONCLUSION AND FUTURE SCOPE

Remote Patient Monitoring systems are very useful because they let the patients live their life and at the same time it provides constant medical attention. The need for visiting the clinic/doctor is pushed to only deserving cases. Offline or online RPM devices are effective patient companions at all times. RPM systems can be used by even seemingly healthy people who may foresee health problems in the future. RPM systems will continue to evolve with increasing awareness, utilization and improving technologies.

IoT Technology is an integration of various technologies which enables different devices and objects to interact with each other and use different network technologies. The proposed model is a well-equipped system where the doctor can check his patient anywhere at any time. The system is implemented for one-to-one access, which can be implemented for many by giving a unique id for each member/patient in the home or the hospital.

As we are moving towards miniaturization, handy electronic components are in need. ARDUINO was found to be more compact, user friendly and less complex. Simulation is performed using Arduino software by placing appropriate sensors like temperature and heart beat rate and blood pressure for sensing the health condition and the results are analyzed under normal conditions and abnormality conditions.

This project can be further enhanced by sensing and displaying other vital statistics of a patient like ECG, blood pressure, glucose level etc. The other thing which is to add is presently we are monitoring the data in Arduino IDE in future we can monitor data in web page using internet of thing technology. In future, a portable health monitoring system can be designed using Arduino

Remote Patient Monitoring comes with a lot of promise and has evolved into a finer service than Telehealth. It is going to continue evolving with time in terms of growth and innovation. The following trends are foreseen in the future for Remote Patient Monitoring:

- Increased adoption of Remote Patient Monitoring in Practice Management and Research.
- Consolidation and convergence of technologies participating in RPM.
- Increasing patient participation in RPM adoption and utilization.
- Improvements in devices and technologies with increasing utilization and information share.
- Application of analytics leading to a better study of patient condition information and the related assessments.

RPM system could find applications in numerous healthcare cases some of which are quoted below:

- **Heart Patients:**

Recovering heart patients could require continuous monitoring to assess the conditions and quick care/medication. Devices which include heart resynchronization therapy and pacemakers are especially useful in preventing problems for heart patients. The diagnostic software combined with the device capabilities could almost double-up as a doctor in the vicinity.

- **Senility or Dementia Problems:**

Old age people often suffer from senility and forgetfulness; this could bring some problems such as losing the way or such people falling down at some places. The surveillance and assistance provided by RPM devices could help such people; if these are GPS enabled, they could even help track their locations.

- **Diabetes and Hypertension Control:**

Diabetic or high BP patients require continuous monitoring and control of blood pressure and blood sugar; this can be achieved by an RPM system that not only monitors but could also provide alerts for controlling them. The diagnostic software could provide not only the

condition but even advice the diet control or medication necessary to bring the blood sugar to acceptable levels.

- **Clinical Trials:**

In specific clinical trials, which may require long-term observation of the subjects during and after the trials, this may be achieved with the RPM systems.

REFERENCES

1. Mr. Bhavin Mehta, Ms. Divya Rengarajan, Mr. Ankit Prasad “Real time patient Tele monitoring system using Lab view” International Journal of science & engineering research, volume 3, issue 4, April 2002.
2. Manju babu, Roshna rose Raju, Sunil Sylvester, Teenu Mary, Matthew, K. M. Abubekar, “Real time patient monitoring system using lab view”, international journal of advanced research in computer and communication engineering, volume 5, issue 3, March 2016.
3. M Priya, M. Kathires, “Wireless patient health monitoring system using lab view”, international journal of emerging technology in computer science and electronics (IJETCSE) ISSN: 0976-1353 volume 22 issue 2, may 2016.
4. M.P. Nirmala, Ram Priya Mahendra, “Home based wireless health monitoring system”, international journal of advanced research in electrical electronics and instrumentation engineering, vol.3, issue 11, November 2014.
5. International Journal of Computer Applications (0975 – 8887) Volume 68– No.7, April 2013.
6. Govinda Swamy, Ravi Kishore Kodali and Boppana Lakshmi, “An Implementation of IoT for Healthcare”, IEEE Recent Advances in Intelligent Computational Systems (RAICS) 10-12 December 2015.
7. Shadi Atalla, Kahtan Aziz, Salah Haj Ismail and SaedTarapiah, “Smart Real-Time Healthcare Monitoring and Tracking System using GSM/GPS Technologies”, 2016 3rd MEC International Conference on Big Data and Smart City.
8. Purnima Puneet Singh, Neetu Rout, Rahul Tiwary, Renuka Bhandari, “Zigbee and GSM based patient health monitoring system” in IEEE explore on International Conference on Electronics and Communication Systems (ICECS) 2014.
9. Y. Zhang and H. Xiao, "Bluetooth-Based Sensor Network for Remotely Monitoring the Physiological Signals of Patient, " in IEEE Trans. on Information Technology in Biomedicine, 13(6), 1040-1048, November 2009.
10. Sagahyroon, H. Raddy, A. Ghazy, and U. Suleman, "Design and Implementation of a Healthcare Monitoring System, " in International. Journal of Electronic Healthcare, 5(1), 68-86, 2009.

Health Monitoring System using Gsm Modem

G. Manmadha Rao, J. Bhavani, N. Siva, N.V.K.S. Vyahruth, K. Sravani



Abstract: The new outbreak of Corona virus poses a major threat and has been declared a global public health emergency. Whole World is trying to stop the virus but no efficient tool and strategy is there to control it. Monitoring of Patient's health remotely is really important especially for patients suffering from a long-term disease. Vital signs such as pulse rate, Body temperature etc., needs to be monitored regularly as they are the primary indicators of a human's health. Also, Elderly people gets benefited by making less visits to the hospitals for regular check-up. Therefore, we intend to bring in a GSM based health monitoring system for patient's which provides security to patient's health. Health monitoring is a technology to enable monitoring patient's health outside clinical settings. The system measures the heartbeat and body temperature of patient and then the immediate information will be sent to the registered number.

Keywords: Body temperature, Heart Rate, Arduino, GSM, Registered mobile number, Miscellaneous.

I. INTRODUCTION

The most familiar Wireless Sensor Networks (WSN) play an important role in the technological community and research which results in the improvement of various high-performance smart sensing system. Mainly innovative research is concentrated at better quality of life in terms of health. This can be achieved by designing and fabricating sensors which are invasive or noninvasive in contact [1]-[2]. Improving health care diagnosis, monitoring and therapy was made possible by the development of biomedical engineering

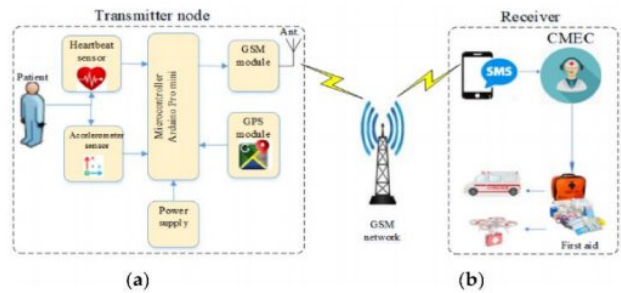

Figure 1. Transmission and Reception of Calculated Parameters.

Fig. 1. shows the Transmission and Reception of the measured values of temperature and heart rate. The vitals are sensed measured and processed using the sensors and micro controller respectively and then the calculated values are sent to the mobile using GSM network as shown in the figure.

The job of the monitoring system is to keep an eye on a particular activity and to make sure that it stays in the desired manner. This can be achieved by using various electronic sensors. Irregularities in pulse rate and inconsistent or high temperatures can lead to serious issues which may finally lead to death of the patient. A Smart Health monitoring system focuses on the safety of patients by monitoring and controlling different parameters affecting Human body.

This project paper is explained as follows. A brief investigation of existing techniques presented in section 2, 3rd section explains the proposed block diagram and methodology, and the components used in the project is described in section 4, Implementation of project is presented in section 5 with results drawn in section 6 and finally concluded in section 7.

II. LITERATURE SURVEY

The pandemic has turned out to be worse. The major hazard for serious illness from Corona Virus is among those aged 80 or older. A system which can be used for preliminary tests such as measuring body temperature and heart rate owes to leave healthcare workers from effected to suspected or quarantined cases is very important.

This provides elder people to escape from any diseases using Internet Of Things (IOT) and some medical devices.[3]-[4] This establishment will help people to know their health status without going outside or medical centers. [5] This is used to check the temperature of patient 24 hours using Zigbee mesh protocol. [6] This is used to check the heart beat per minute and temperature of body and pass the information to them using GSM module and web technologies and GPS to save patient's life on time without any delay.

Manuscript received on 06 May 2022.
Revised Manuscript received on 13 May 2022.
Manuscript published on 30 June 2022.

* Correspondence Author

Dr. G. Manmadha Rao*, Department of Electronics and Communication Engineering, Anil Neerukonda Institute of Technology and Sciences, Visakhapatnam (Andhra Pradesh), India. E-mail: profmanmadharao.ece@anits.edu.in

J. Bhavani, Department of Electronics and Communication Engineering, Anil Neerukonda Institute of Technology and Sciences, Visakhapatnam (Andhra Pradesh), India.

N. Siva, Department of Electronics and Communication Engineering, Anil Neerukonda Institute of Technology and Sciences, Visakhapatnam (Andhra Pradesh), India.

N.V.K.S. Vyahruth, Department of Electronics and Communication Engineering, Anil Neerukonda Institute of Technology and Sciences, Visakhapatnam (Andhra Pradesh), India.

K. Sravani, Department of Electronics and Communication Engineering, Anil Neerukonda Institute of Technology and Sciences, Visakhapatnam (Andhra Pradesh), India.

© The Authors. Published by Blue Eyes Intelligence Engineering and Sciences Publication (BEIESP). This is an open access article under the CC-BY-NC-ND license <http://creativecommons.org/licenses/by-nc-nd/4.0/>

Health Monitoring System using Gsm Modem

[7] It gives a remedy for enhancing the flexibility and reliability by increasing the power management and performance of the monitoring system of patient.[8] It gives the architecture of proposed model for measuring heart rate and temperature using Bluetooth techniques.

[9] It describes that an SMS will be sent to registered mobile after measuring biological data using wearable sensor device.[10] Present medical support in growing countries allows suffering people to appear physically for regular health check-up or patient needs to get admitted for regular observation.

The system is time consuming and non-flexible. Today remote sensor system allows patients to control their daily lifestyle constantly from anywhere at any places. Hence, to support real time patient health monitoring, in this work we propose constant health monitor of a person by transmitting one's body temperature and heart rate's data utilizing GSM modem to a web server that is accessible to both doctor and the patient.

III. BLOCK DIAGRAM AND WORKING PRINCIPLE

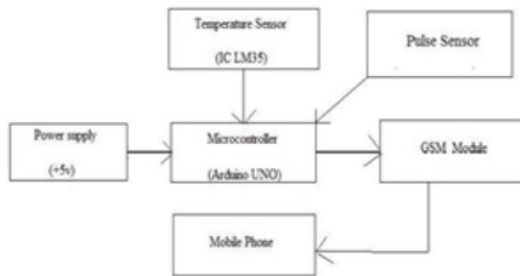

Figure 2. Block Diagram of Remote health monitoring system

Fig. 2. Shows the basic blocks in a propose model it checks the temperature of body and heart beats remotely. The block diagram shown in the figure consists of a power supply of 5V, Temperature sensor (LM35), Pulse sensor, Arduino UNO, GSM Module and a Mobile phone.

An open-source platform which is Arduino for electronic projects. It consists of both programmable circuit which is physical in nature called micro controller and an IDE (Integrated Development Environment) which runs on our system and it is used to write and upload code to the board. There are sensors to measures and monitors the vital signs like temperature and heart beats. The LM35 sensor and pulse rate sensor will measure the body temperature and heart beats per minute when we place the finger on sensors. LCD [Liquid Crystal Display] is a 16x2 display that displays the values from the sensors.

IV. COMPONENTS USED IN THE PROJECT

A. Arduino (Atmega 328)

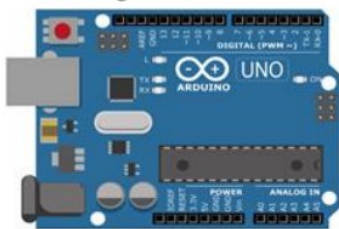

Figure 3. Arduino UNO

Arduino UNO helps in high-speed programming. It has 28 Pins in total. 20 I/O ports are available to user in which 14 are digital and 6 are analog inputs. ATMEGA 328 is an 8-bit micro controller which means it can process 8 data lines in single clock pulse and it is open sourced. Specifications:

- 5V- Operating voltage
- 7-12V Recommended input voltage
- 32KB flash memory in which 0.5KB used by Bootloader
- Clock input required is 16MHZ
- EEPROM data memory is up to 1KB

B. Temperature Sensor (Lm35)

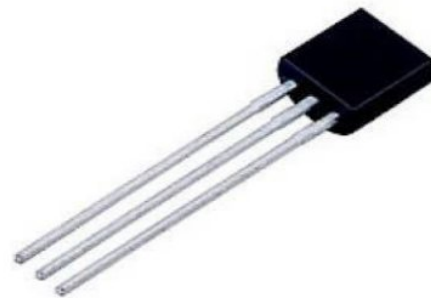

Figure 4. Temperature Sensor (LM35)

It is an integrated circuit made of Semi-conductors. LM stands for Linear Monolithic. It is a precision integrated temperature sensor. It produces analog output in linear form. This sensor provides an output voltage of 10.0mV for each degree of temperature from a reference voltage.

Specifications:

- It operated in the range of 4 to 30V
- It doesn't require an external calibration. It is designed directly in centigrade.
- -55°C to 150°C is temperature range.
- Ensured Accuracy of 0.5°C (at +25°C).
- It uses only 60µAmps from source and possesses a low self-heating capability.

C. Pulse Sensor



Figure 5. Pulse sensor

It is an open- source heart sensor. This sensor clips on to a Finger-tip or earlobe or any place on the skin where capillary veins are being sensed.

This sensor works on the principle of Photo Lithosmography.

Its principle says that the using intensity changes of light travelling through the organ can measure the volume of blood in an organ.

When the front side of sensor is placed over a vein in our body (finger/ear), LED blows light and the veins will have flow of blood. We will observe the blood flow. If the blood flow is detected, more light will be effected by the blood.

Features:

- Biometric heart rate detecting sensor.
- +5V to +3.3v is Operating voltage.
- 4mA is current consumption.
- Inbuilt noise cancellation and amplification circuit.

D. Gsm Modem



Figure 6. GSM Modem

Global system for mobile communication is the abbreviation of GSM. It is used to make calls, send SMS, smart home appliance etc. For the purpose of communication, it requires power supply up to 12V, RS232 is communication interface, and a SIM card which is similar to the mobile phone to establish communication with the network. To change the modes of GSM we use AT commands.[5]

- GSM 900A is a quad band version operated in 850/900/1000MHz. It will work for 2G sim.
- It needs 12V (230V converted into 12V by transformer).
- GSM works with less speed than Arduino.
- To get signal for GSM, Network LED is there, it blinks for every 3 sec.

Table-I. GSM AT-Commands

| AT-Commands | Description |
|-------------|---------------------------|
| AT | Enter |
| AT+CMGF | Select SMS Message Format |
| AT+CMGS | Send SMS Message |

E. 16x2 Lcd Display



Figure 7. LCD Display

It is a very basic module and it can display 16 characters per line. It is used to display the values from the temperature sensor and pulse sensor.

V. IMPLEMENTATION

The methodology to monitor the Heart rate and body temperature is implemented in the following manner to be discussed in the rest of the section. The prime requirements are listed below:

A. Hardware requirements:

- Arduino Uno
- 16X2 LCD Display
- LM35 Temperature Sensor
- Pulse Sensor
- GSM Module
- Jumper Wires

B. Software requirements:

- Arduino IDE

The circuit is initialized when the switch is turned ON. After pressing reset, finger is placed on the temperature sensor and then the pulse sensor respectively.

Then the measurement of heart rate and temperature takes place. We can sense the pulse in some blood vessels which are very close to the skin surface such as wrist, neck surface, upper arm etc. The heart rate count for nearly 30 sec and then it is converted into bpm.

Simultaneously, the body temperature is measured.

Body temperature = 98.6°F or 39°C. Body temperature is usually affected by the part of the body and also time of the day. It is lower in the morning due to the rest taken at night and it is high in the evening due to the muscular activity throughout the day.

Final measured values of body temperature and pulse rate are passed to the doctor or to the relatives of patient by GSM modem using AT+CMGS command.

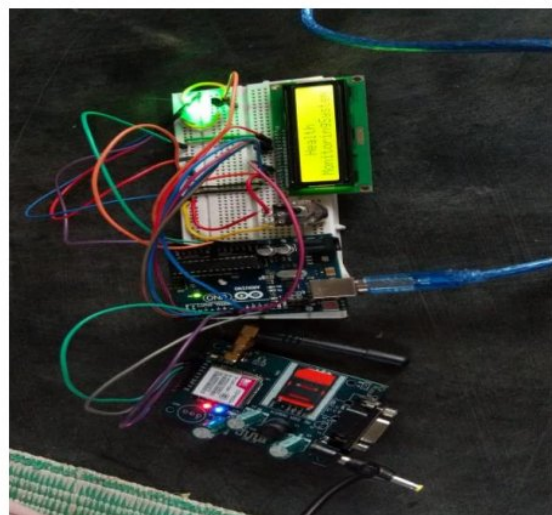

Figure 8. Hardware Setup

The values from the sensors that are obtained are given to the Arduino as the sensors are connected to the pins of the Arduino board. If the values obtained from the sensors reach the critical values, then as per the code written in the Arduino Software, then we get a display regarding the condition of patient.

Flow chart of Proposed system:

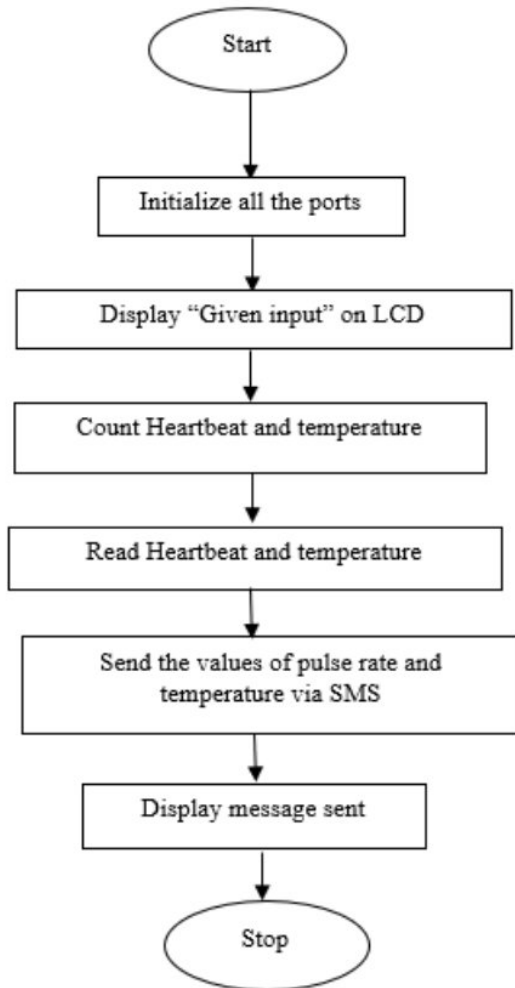

Figure 9. Flow chart of the proposed system

Assemble all the required components and start connecting the model and initialize all the ports and dump the code from Arduino IDE to Arduino UNO and then verify and upload the code. The message “Given input” will be displayed on the LCD. For counting and reading the temperature and heartbeat biological data, touch the temperature sensor and pulse sensor. The output will be displayed on the LCD and GSM model will send the values of pulse rate and temperature via SMS to the registered mobile number. After sending the message the message sent will be displayed on the LCD with this the procedure is completed.

VI. RESULTS

The values of body temperature and heart rate was measured for different patients and the values are noted.

Table-II Output at Tested Conditions

| S. No | Body Temperature (Celsius) | Body Temperature (Fahrenheit) | Heart Rate (BPM) |
|----------|----------------------------|-------------------------------|------------------|
| PERSON 1 | 28.32 | 82.98 | 72 |
| PERSON 2 | 37.22 | 99 | 101 |

The details of the condition of patient are displayed on the LCD.

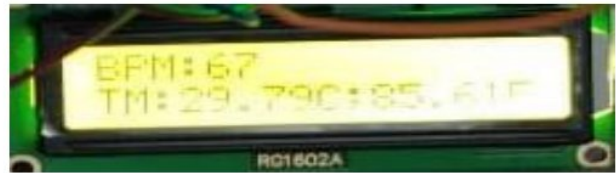

Figure 10. LCD showing the measured values.



Figure 11. LCD display after the message was sent.

After the measuring of temperature and heart rate is done, then the message will be sent to the registered number and a message saying “Message was sent” will be seen on the LCD. Whenever the message is received the doctor or the relative of patient sees this notification and they can ensure safety on patient’s health.

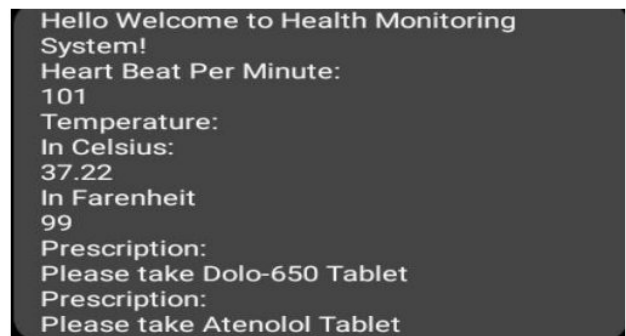
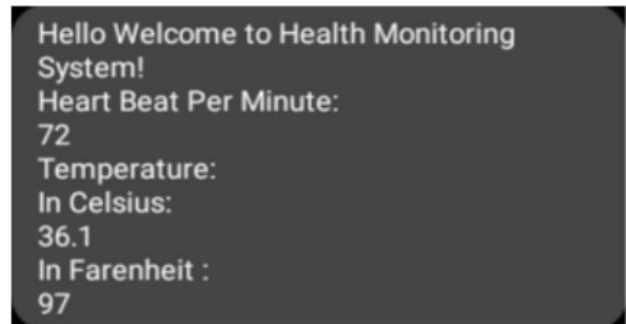

Figure 12. Output of the developed system

VII. CONCLUSION

The integrated IoT-based health monitoring approach using GSM that can measure various vital signs such as temperature of body and pulse rate is built. Users also can get output in the form of notification through the LCD and can also get a message through the GSM. The main agenda of establishing this model is to alert the doctor or relatives of patient about the current health condition of the patient via mobile phone. This system improves chronic condition management, reduces emergency situations and increases patient’s accountability.



This module is applicable for Hospital, home and also in ambulance. This project can be further enhanced by sensing and displaying other vital signs like ECG, blood pressure and glucose levels of a patient.

REFERENCES

1. Mr. Bhavin Mehta, Ms. Divya Rengarajan, Mr. Ankit Prasad "Real time patient Tele monitoring system using Lab view" International Journal of science & engineering research, volume 3, issue 4, April 2002.
2. Manju babu, Roshna rose Raju, Sunil Sylvester, Teenu Mary, Matthew, K. M. Abubekar, "Real time patient monitoring system using lab view", international journal of advanced research in computer and communication engineering, volume 5, issue 3, March 2016.
3. M Priya, M. Kathiresh, "Wireless patient health monitoring system using lab view", international journal of emerging technology in computer science and electronics (IJETCSE) ISSN: 0976-1353 volume 22 issue 2, may 2016.
4. M.P. Nirmala, Ram Priya Mahendra, "Home based wireless health monitoring system", international journal of advanced research in electrical electronics and instrumentation engineering, vol.3, issue 11, November 2014.
5. International Journal of Computer Applications (0975 - 8887) Volume 68- No.7, April 2013.
6. Govinda Swamy, Ravi Kishore Kodali and Boppana Lakshmi, "An Implementation of IoT for Healthcare", IEEE Recent Advances in Intelligent Computational Systems (RAICS) 10-12 December 2015.
7. Shadi Atalla, Kahtan Aziz, Salah Haj Ismail and Saed Tarapiah, "Smart Real-Time Healthcare Monitoring and Tracking System using GSM/GPS Technologies", 2016 3rd MEC International Conference on Big Data and Smart City.
8. Purnima Puneet Singh, Neetu Rout, Rahul Tiwary, Renuka Bhandari, "Zigbee and GSM based patient health monitoring system" in IEEE explore on International Conference on Electronics and Communication Systems (ICECS) 2014.
9. Y. Zhang and H. Xiao, "Bluetooth-Based Sensor Network for Remotely Monitoring the Physiological Signals of Patient, " in IEEE Trans. on Information Technology in Biomedicine, 13(6), 1040-1048, November 2009.
10. Sagahyroon, H. Raddy, A. Ghazy, and U. Suleman, "Design and Implementation of a Healthcare Monitoring System, " in International. Journal of Electronic Healthcare, 5(1), 68-86, 2009.

AUTHORS PROFILE



Dr. G Manmadha Rao, has completed his Bachelor of Engineering, Masters of Engineering in ECE at AU College of Engineering, Andhra University during 1998 and 2003 respectively. He has completed his PhD in RADAR field at Dept. of ECE, Andhra University in 2014. Has published more 43 research papers in International/National Journals and Conferences. Has 21 years of Teaching and 9 years of Industry experience. Currently, He is working as Professor in ECE Dept., ANITS.



Ms. J Bhavani, is pursuing her IV B.Tech in ECE discipline at ANITS. She got selected for Wipro with 6.5LPA. She also attended many workshops/FDPs on IOT and Web Development. She is awarded with cash prize for her Academic Excellence in 1st and 3rd years.



Mr. N Siva, is pursuing his IV B.Tech in ECE discipline at ANITS. He got selected for Wipro with 6.5LPA. He also attended many workshops/FDPs on web development.



Mr. N V K S Vyahruth, is pursuing his IV B.Tech in ECE discipline at ANITS. He got selected for Infosys with 6.25LPA. He also attended many workshops/FDPs on web development and IOT.



Ms. K Sravani, is pursuing her IV B.Tech in ECE discipline at ANITS. She has attended workshop on IOT.